



MONOBLOC DRIVE AOWD 75TX

Serie

MONOBLOC DRIVE

Edition

12/25

Models

AOWD 75TX

Warmlink APP



CONTENT

1 Preface	1
2 Safety Precaution	2
(1) Mark Notes	2
(2) Icon notes	2
(3) Warning	3
(4) Attention	4
3 Specification	5
(1) Appearance and structure of the heat pump	5
(2) The data of unit	5
(3) Unit dimension	6
4 Installation	7
(1) Application of heat pump	7
(2) Choose a right heat pump unit	8
(3) Installation method	8
(4) Installation place	9
(5) Refrigerant charge	9
(6) Water loop connection	10
(7) Power supply connection	10
(8) Location of the unit	10
(9) Transit	11
(10) Trial Running	12
5 Operation and Use	13
(1) Main interface display and function	13
(2) Function setting	17
(3) Error Code Instruction	21
(4) Controller interface diagram and definition	25
6 Maintenance and Inspection	29
7 Appendix	34
(1) Appendix 1	34
(2) Appendix 2	35

Preface

- In order to provide the customers with high quality, strong reliability and good versatility product, this heat pump is produced by strict design and manufacture standards.

This manual includes all the necessary information about installation, debugging, discharging and maintenance. Please read this manual carefully before you open or maintain the unit.

The manufacture of this product will not be held responsible if someone is injured or the unit is damaged, as a result of improper installation, debugging, unnecessary maintenance which is not in line with this manual.

The unit must be installed by qualified personnel.

- It is vital that the below instructions are adhered to at all times to keep the warranty.

—The unit can only be opened or repaired by qualified installer or an authorised dealer.

—Maintenance and operation must be carried out according to the recommended time and frequency, as stated in this manual.

—Use genuine standard spare parts only.

Failure to comply with these recommendations will invalidate the warranty.

- Inverter air source water heat pump is a kind of high efficiency, energy saving and environment friendly equipment, which is mainly used for house warming. It can work with any kind of indoor unit such fan coil, radiator, or floor heating pipe, by provide warm or hot water. One unit of monobloc heat pump can also work with several indoor units.

The air source water heat pump unit is designed to have heat recovery by using super heater which can provide hot water for sanitary purpose.

This series of heat pump unit owns following features:

1 Advanced controlling

The PC microcomputer based controller is available for the users to review or set the running parameters of the heat pump. Centralized controlling system can control several units by PC.

2 Nice appearance

The heat pump is designed with beautiful looking. The monobloc one has the water pump included which is very easy for installation.

3 Flexible installation

The unit has smart structure with compact body, just simple outdoor installation is needed.

4 Quiet running

High quality and efficient compressor, fan and water pump is used to ensure the low noise level with insulation.

5 Good heat exchange rate

The heat pump unit use special designed heat exchanger to enhance whole efficiency.



6 Large working range

This series of heat pump is designed to work under different working conditions as low as -25 degrees for heating.



Safety Precaution

To prevent the users and others from the harm of this unit, and avoid damage on the unit or other property, and use the heat pump properly, please read this manual carefully and understand the following information correctly.

Mark Notes



Mark	Meaning
 WARNING	A wrong operation may lead to death or heavy injury on people.
 ATTENTION	A wrong operation may lead to harm on people or loss of material.



Icon notes



Icon	Meaning
	Prohibition. What is prohibited will be nearby this icon
	Compulsory implement. The listed action need to be taken.
	ATTENTION (include WARNING) Please pay attention to what is indicated.

Safety Precaution

Warning

Installation	Meaning
 Professional installer is required.	The heat pump must be installed by qualified personals, to avoid improper installation which can lead to water leakage, electrical shock or fire.
 Earthing is required	Please make sure that the unit and power connection have good earthing, otherwise may cause electrical shock.

Operation	Meaning
 PROHIBITION	DO NOT put fingers or others into the fans and evaporator of the unit, otherwise harm may be occurred.
 Shut off the power	When there is something wrong or strange smell, the power supply need to be shut off to stop the unit. Continue to run may cause electrical short or fire.

Move and repair	Meaning
 Entrust	When the heat pump need to be moved or installed again, please entrust dealer or qualified person to carry it out. Improper installation will lead to water leakage, electrical shock, injury or fire.
 Entrust	It is prohibited to repair the unit by the user himself, otherwise electrical shock or fire may be occur.
 Prohibit	When the heat pump need to be repaired, please entrust dealer or qualified person to carry it out. Improper movement or repair on the unit will lead to water leakage, electrical shock, injury or fire.









Do not use means to accelerate the defrosting process or to clean, Other than those recommended by the manufacturer.

The appliance shall be stored in a room and installed in the environment without continuously operating or potential ignition sources (for example: open flames, an operating gas appliance or an operating electric heater or Electric Spark or hot object)

Safety Precaution

ATTENTION

Installation	Meaning
 Installation Place	The unit CANNOT be installed near the flammable gas. Once there is any leakage of the gas, fire can occur.
 Fix the unit	Make sure that the basement of the heat pump is strong enough, to avoid any decline or fall down of the unit
 Need circuit breaker	Make sure that there is circuit breaker for the unit, lack of circuit breaker can lead to electrical shock or fire.

Operation	Meaning
 Check the installation basement	Please check the installation basement in a period (one month), to avoid any decline or damage on the basement, which may hurt people or damage the unit
 Switch off the power	Please switch off the power for clean or maintenance.
 Prohibition	It is prohibited to use copper or iron as fuse. The right fuse must be fixed by electrician for the heat pump.
 Prohibition	It is prohibited to spray the flammable gas to the heat pump, as it may cause fire.

Specification

1. Appearance and structure of the heat pump

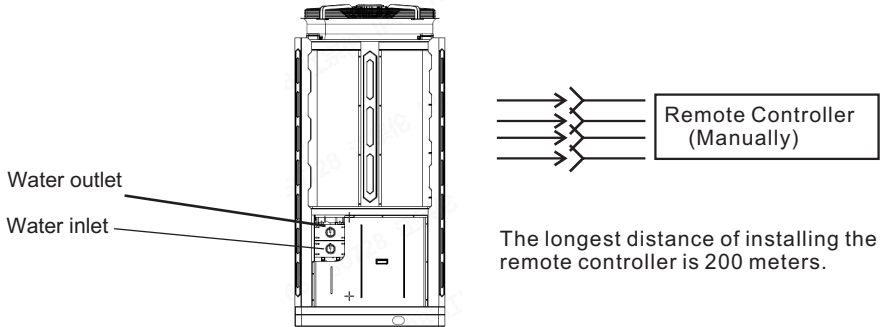

2. The data of unit

*** REFRIGERANT : R290

Model		AOWD 75TX
Heating Capacity(A)	KW	30.00-110.00
Heating Power Input(A)	KW	8.57-32.70
Cooling Capacity(B)	KW	24.55-90.00
Cooling Power Input(B)	KW	9.74-35.7
Hot Water Capacity(C)	KW	38.00-140.00
Hot Water Power Input(C)	KW	10.28-37.70
Maximum Power Input	KW	42.64
Maximum consumption	A	66.11
Power Supply		380~415V/3N~/50Hz
Compressor Quantity		2
Compressor Model		Scroll
Fan Quantity		2
Fan Power Input	W	2200
Fan Rotate Speed	RPM	980
REFRIGERANT	Kg	R290/4.7 kg*2
Noise	dB(A)	60
Water Connection	inch	G"2.5
Water Flow Volume	m3/h	12.04
Internal Water Pressure Drop	KPa	74
Residual Pressure	m	4.1
Unit Net Dimensions (L/W/H)	mm	2275*1150*2457
Unit Shipping Dimensions (L/W/H)	mm	2350*1150*2510
Net Weight	Kg	963
Shipping Weight	Kg	1100

A: AMBIENT TEMP.(DB/WB): 7°C/6°C,WATER TEMP.(IN/OUT):30°C/35°C

B: AMBIENT TEMP.(DB/WB): 35°C/24°C,WATER TEMP.(IN/OUT):12°C/7°C

C: AMBIENT TEMP.(DB/WB): 20°C/15°C,WATER TANK TEMPERATURE CIRCULATION FROM 15°C TO 55°C

BS EN 14511-1-2013 Air conditioner, whole liquid cooling machine, electric compressor.

Part2: Test condition ; Part3:Test method ; Part4:related requirements.

Specification

3. Unit dimension

Models: AOWD 75TX

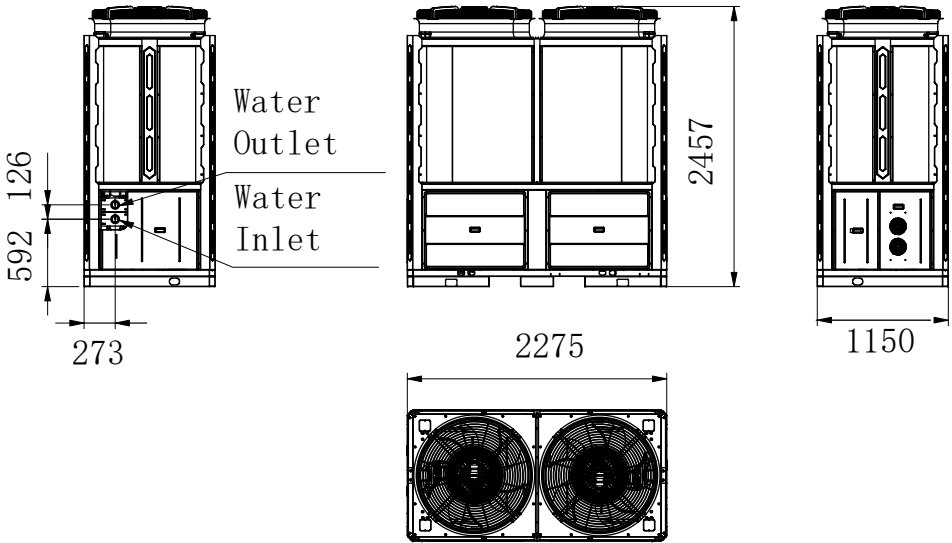

Installation

Unit features

1. Plate heat exchanger

Use the SWEP efficient heat exchanger with small size and high efficiency.

2.Environmentally friendly refrigerant

Use the new generation of environmentally friendly refrigerant R290, which is harmless to the ozone sphere.

3. Heating in frigid environment and high temperature water output

Optimized designed unit can achieve the heating function normally even when the ambient temperature is -25°C, Maximum water temperature 75°C.

4. Infusing refrigerant

The Heat Pump are lack of refrigerant and full of High-pressure nitrogen instead when Ex-factory . Before operating ,remember follow Operation Manual infusing therefrigerant .

5. Installation Environment

The refrigerant R290 are flammable and explosive ,It's prohibit install in one environment which have operating or potential ignition sources .

1 Application of heat pump

1.1 House Heating/Cooling + Domestic Hot Water

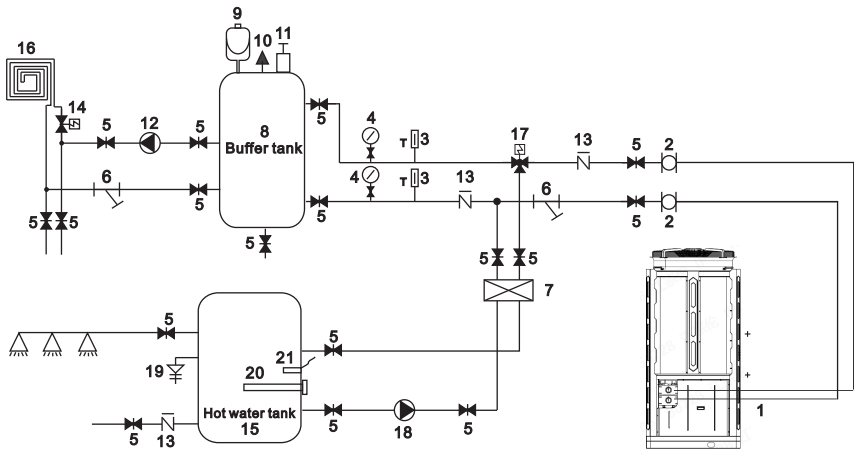

1	Heat pump	10	Relief valve	19	PTvalve
2	Flexible pipe	11	Air vent valve	20	Electrical heater
3	Thermometer	12	Water pump for floor heating	21	Hotwater sensor
4	Manometer	13	Check valve		
5	Shut-off valve	14	Floor heating valve		
6	Ytype water filter	15	Hot water tank		
7	Plate heat exchanger	16	Floor heating pipe/fan coil unit		
8	Buffer tank	17	Hot water valve		
9	Expansion tank	18	Hot water pump		

Remark:Item 17, 18, 20, 21 can be connected with heat pump.

Installation

1.2 House Heating/Cooling (includes Buffer tank)

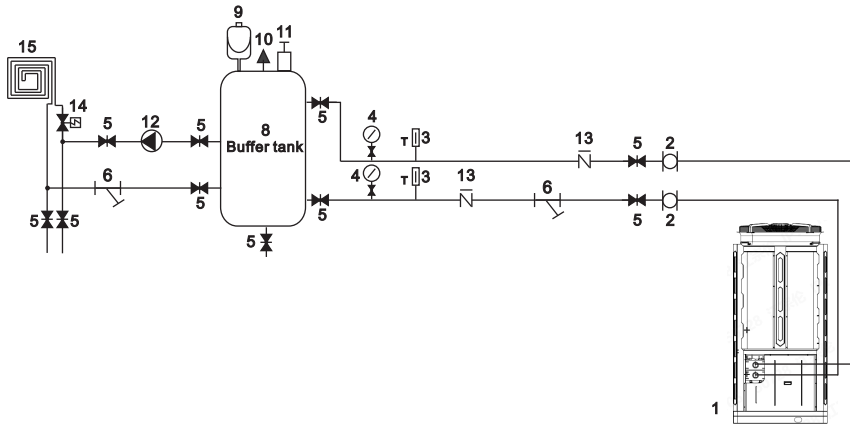

1	Heat pump	7	Plate heat exchanger	13	Check valve
2	Flexible pipe	8	Buffer tank	14	Floor heating valve
3	Thermometer	9	Expansion tank	15	Floor heating pipe/fan coil unit
4	Manometer	10	Relief valve		
5	Shut-off valve	11	Air vent valve		
6	Y type water filter	12	Water pump for floor heating		

2 Choose a right heat pump unit

- 2.1 Based on the local climate condition, construction features and insulation level, calculate the required cooling(heating) capacity per square meter.
- 2.2 Conclude the total capacity which will be needed by the construction.
- 2.3 According to the total capacity needed, choose the right model by consulting the heat pump features as below:

Heat pump features

- Heating and Cooling unit: for cooling, chilled water outlet temp. at 7 -21 °C ,maximum ambient temp. at 43 °C. For heating, warm water outlet temp. at 15 -80 °C, minimum ambient temp. at -25 °C.
- Unit application
Inverter air source water heat pump is used for house, office, hotel, and so forth, which need heating or cooling separately, with each area need to be controlled.

3 Installation method

The heat pump can be installed onto the concrete basement by expansion screws, or onto a steel frame with rubber feet which can be placed on the ground or housetop. Make sure that the unit is placed horizontally.

Installation

4 Installation place

- The unit can be installed on any place outdoor which can carry heavy machine such as terrace, housetop, ground and so on.
- The location must have good ventilation.
- The place is free from heat radiation and other fire flame.
- A pall is needed in winter to protect the heat pump from snow.
- There must be not obstacles near the air inlet and outlet of the heat pump.
- A place which is free from strong air blowing.
- There must be water channel around the heat pump to drain the condensing water .
- There must be enough space around the unit for maintenance.
- A place which is far away operating or potential ignition sources (for example:open flames, an operating gas appliance or an operating electric heater or Electric Spark or hot object)

5 Refrigerant charge

The heat pump is charged with R290 refrigerant, but if it need to be charged follow these steps to charge R290 refrigerant.

5.1 Preparations:

- 5.1.1 Please in a well-ventilated environment while charge refrigerant.
- 5.1.2 Keep away from open flames or potential sources of fire.
- 5.1.3 Disconnect the power supply of the heat pump.
- 5.1.4 Carefully check the nameplate of the heat pump and charge strictly according to the labeled amount.

5.2. Check the pressure of nitrogen gas inside the system. The heat pump has charged about 30 Bar pressure nitrogen gas inside the system, please check whether there is still high-pressure nitrogen before charging refrigerant, otherwise check the leakage point. (Use spanner remove the seal nut 1 and 3 , use 5mm inner hexagon spanner open the valve 2. If it can Blowing out the high-pressure gas then the heat pump is not leaking.)

- 5.3. Use 5mm inner hexagon spanner open the valve 2 and release all the nitrogen gas inside the system.
- 5.4. Vacuumize the heat pump. Connect the vacuume pump with the valve 2, keep vacuume pump running until the absolute pressure below 30Pa or operating time more than one hour.
- 5.5. Charge refrigerant. Keep the refrigerant in liquid state when charging and strictly according to the labeled amount.
- 5.6. Finish the charging, close the valve 2 and screw the seal nut 1 and 3.

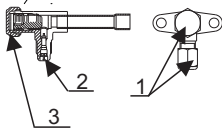
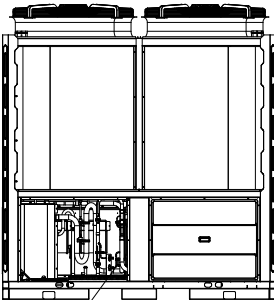

Stop valve signs:
Low pressure

Installation

6 Water loop connection

Please pay attention to below matters when the water pipe is connected:

- Try to reduce the resistance to the water from the piping.
- The piping must be clear and free from dirty and blocks. Water leakage test must be carried out to ensure there is no water leaking. And then the insulation can be made.
- Attention that the pipe must be tested by pressure separately. DO NOT test it together with the heat pump.
- There must be expansion tank on the top point of the water loop, and the water level in the tank must be at least 0.5 meter higher than the top point of the water loop.
- The flow switch is installed inside of the heat pump, check to ensure that the wiring and action of the switch is normal and controlled by the controller.
- Try to avoid air stayed inside of the water pipe, and there must be air vent on the top point of the water loop.
- There must be thermometer and pressure meter at the water inlet and outlet, for easy inspection during running.

7 Power supply connection

- Open the front panel, and open the power supply access.
- The power supply must go through the wire access and be connected to the power supply terminals in the controlling box. Then connect the 3-signal wire plugs of the wire controller and main controller.
- If the outside water pump is needed, please insert the power supply wire into the wire access also and connect to the water pump terminals.
- If an additional auxiliary heater is need to be controlled by the heat pump controller, the relay (or power) of the aux-heater must be connected to the relevant output of the controller.

8 Location of the unit

The unit can be installed separately or in multiple. When multiple units are installed in combination, attention should be paid to their arrangement.

Installation space for single unit: (unit: mm)

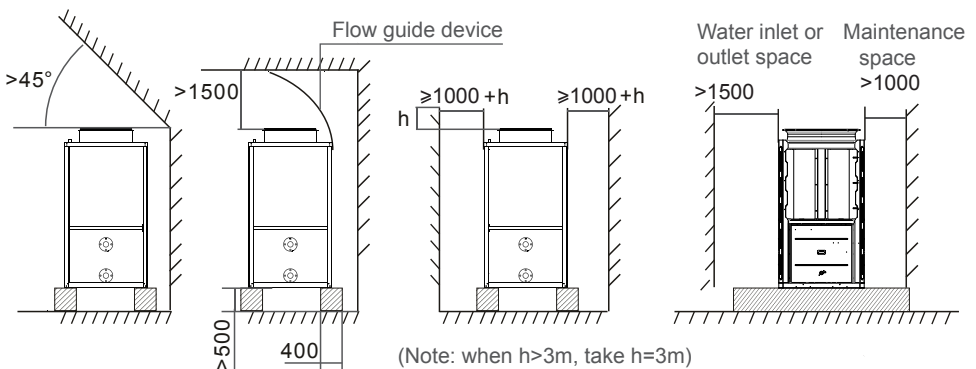

Installation

Installation space for multiple units (same pipe length): (unit: mm)

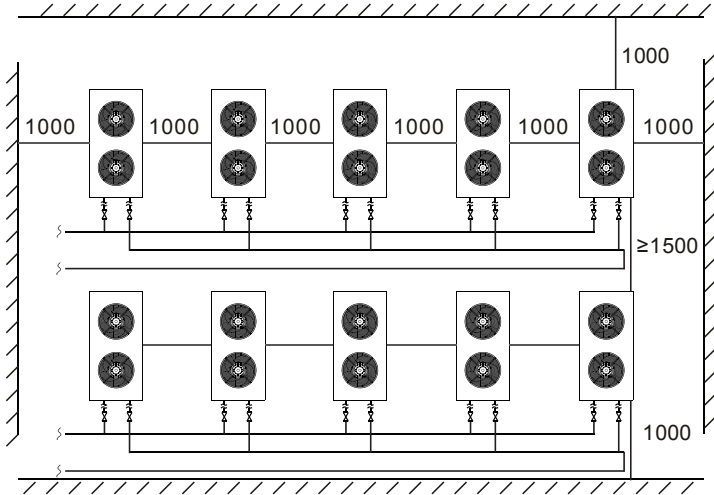

- Note:
- Do not cover the air outlet of the unit;
 - If there is a barrier above the unit, please keep it 3000mm above the unit;
 - If there are objects stacked around the unit, its height should be at least 400mm lower than the top of the unit;
 - When installed in a small room, certain measures should be taken to prevent the leakage of refrigerant. Once leakage volume exceeds the limit concentration, it may cause suffocation. Please consult your dealer for specific measures.

9 Transit

When the heat pump is transported please keep the unit stand up. The unit cannot be laid down, otherwise the inner parts of the device may be damaged.

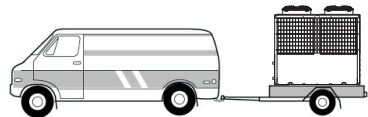

Installation

When the unit need to be hung up during installation, a 8 meters cable is needed, and there must be soft material between the cable and the unit to prevent damage to the heat pump cabinet. (See picture 1)

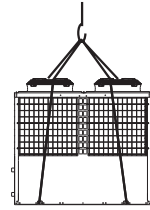

Picture 1

Or please use forklift, since there is wood chassis as package.

 WARNING	DO NOT touch the heat exchanger of the heat pump with fingers or other objects!
---	--

10 Trial Running

Inspection before trial running

- Check the indoor unit, and make sure that the pipe connection is right and the relevant valves are open .
- Check the water loop, to ensure that the water inside of the expansion tank is enough, the water supply is good, the water loop is full of water and without any air. Also make sure there is good insulation for the water pipe.
- Check the electrical wiring. Make sure that the power voltage is normal, the screws are fastened, the wiring is made in line with the diagram, and the earthing is connected.
- Check the heat pump unit including all of the screws and parts of the heat pump to see if they are in good order. When power on, review the indicator on the controller to see if there is any failure indication. The gas gauge can be connected to the check valve to see the high pressure(or low pressure) of the system during trial running.

Trial running

- Start the heat pump by press "⏻" key on the controller. Check whether the water pump is running, if it runs normally there will be 0.2 MPa on the water pressure meter.
- When the water pump runs for 1 minutes, the compressor will start. Hear whether there is strange sound from the compressor. If abnormal sound occurs please stop the unit and check the compressor. If the compressor runs well please look for the pressure meter of the refrigerant.
- Then check whether the power input and running current is in line with the manual. If not please stop and check.
- Adjust the valves on the water loop, to make sure that the hot(cool) water supply to each door is good and meet the requirement of heating(or cooling).
- Review whether the outlet water temperature is stable.
- The parameters of the controller are set by the factory, it is not allowed to change then by user himself.

1. Main interface display and function

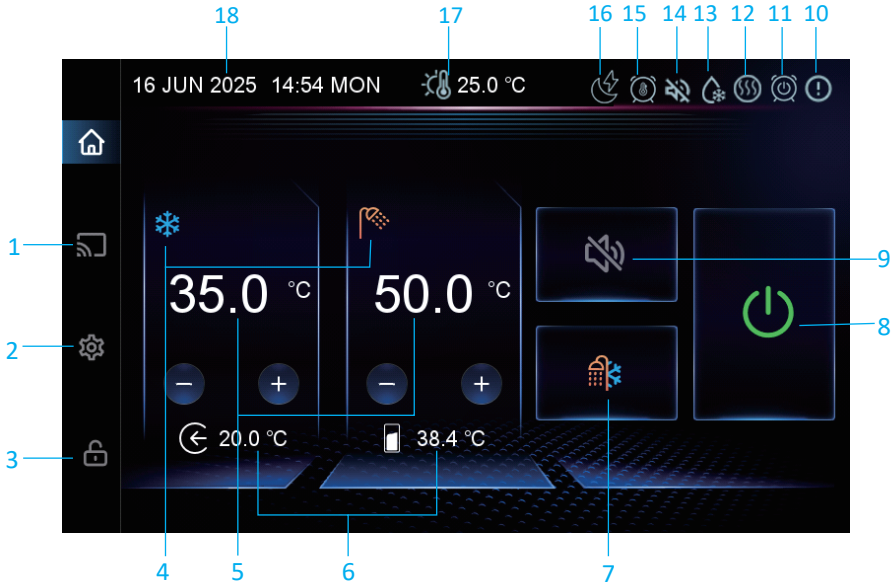

Operation and Use

	Name	Description of operation
1	Engineering information	Click to view the engineering information, unit status, curve, real-time fault
2	Function setting	Click to enter the function setting interface
3	Lock screen	Lock screen button, unlock password 22
4	Current mode	Display a dynamic icon when the unit is running
5	Target temp	Display the current mode target temp,adjustable
6	Current temp	Display according to H28, and the tank temp is displayed when the hot water mode is selected
7	Mode	Click to choose the mode: DHW, heating, cooling, cooling+DHW, heating+DHW
8	On/off	Power ON/OFF button, green indicates ON and gray indicates OFF
9	One-click mute	Click to mute
10	Fault icon	Display when the unit fails,click to enter the real-time fault interface
11	Power timer	Display when the power on/off timer is enabled
12	Electric heater icon	Display when electric heating is on
13	Defrosting icon	Display when the unit is defrosting
14	Mute icon	Display when the unit is mute
15	Schedule icon	Display when the schedule timer is enabled
16	SG Ready icon	Display SG current mode icon
17	AT	Display the ambient temp
18	System time	Display the current real-time time

Remark:

If the device enter the AT Compensation and Schedule, the target temp. cannot be set and the corresponding text prompts are displayed.

Operation and Use

1.1 Mode switch

Click on the icon to switch to the corresponding selection mode, after setting automatically return to the main interface.

The mode setting screen is displayed according to the H46 and H47 parameters, with up to 5 modes selectable.

- H46=0&H47=0, only heating is displayed;
- H46=1& H47=0, heating and cooling is displayed;
- H46=0&H47=1, heating and DHW, heating + DHW is displayed;
- H46=1&H47=1, 5 modes are displayed;
- H47=2, only DHW is displayed.



1.2 Engineering information

Click the  button in the main interface to enter the project interface.

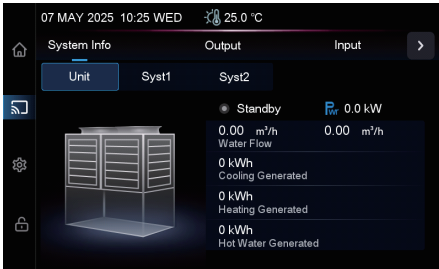

System Info allows you to view the following information:

- Unit state, Unit power, Water Flow, Cooling generated, Heating generated, Hot water generated
- Unit diagram: Display different pictures depending on the model
- System diagram: H02=1 for single system does not show syst2, click to view the corresponding system diagram

1.3 Unit State

Click the corresponding status button to view the relevant status parameters of the unit.

The operating data of the heat pump can be accessed from here. Status parameters are viewable only and cannot be modified.

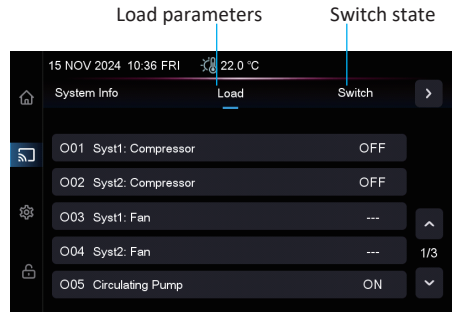

1.4 Curve

Click the Curve button to enter the curve recording interface.

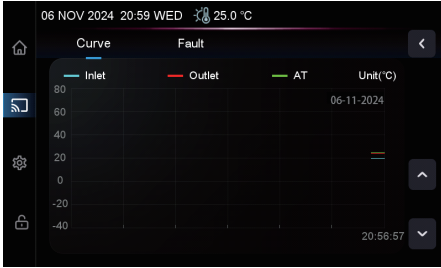

- This curve function records the water inlet temp, outlet temp and AT temp
- Temp data is collected and saved every 5 minutes and save up to 30 days of data
- Only curve for power-on status is recorded, and that for power-off will not be saved
- Temp curve record is provided with power-down memory function
- The value of the abscissa indicates the time from the point on the curve to the current time point. The rightmost point on the first page is the latest temp record. Page up and down to view historical data

1.5 Fault interface

Click the Fault button to enter the real-time fault interface, if the fault recovers, it is no longer displayed.

Detailed information on the faults and their solutions can be found in the fault table at the end of the manual.



2. Function setting

Click the  button in the main interface to enter the project interface.

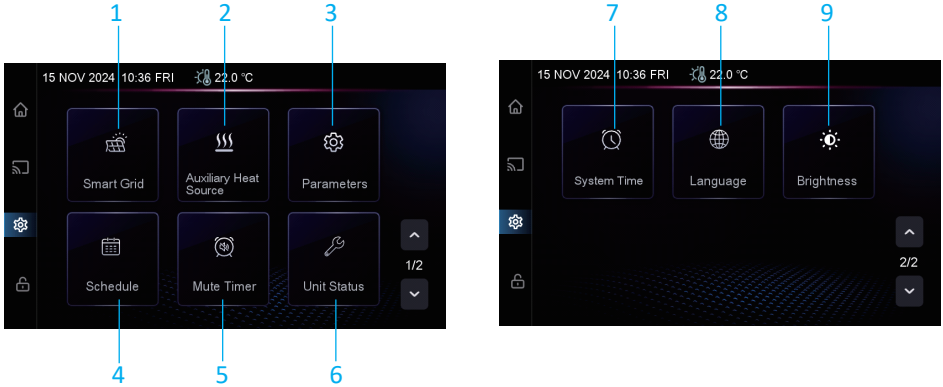





No.	Name	Description of operation
1	Smart Grid	Click to enter the SG function interface
2	Auxiliary Heat Source	Click to enter the auxiliary heat function interface
3	Parameters	Click the key and enter the password to enter the factory parameter settings and status parameters
4	Schedule	Click to enter the interface of timer on/off setting and schedule control setting
5	Mute Timer	Click to enter the mute timer ininterface
6	Unit Status	Click to customer function configuration menu
7	System Time	Click to set the system time
8	Language	Click to change the language
9	Brightness	Click to adjust screen brightness

Operation and Use

2.1 Smart Grid function

Click the  button in the project interface to enter the SG function interface.

Through one or two contacts, the device receives information on available energy (from the PV system or the electricity supplier) and selects one of the 5 modes based on this information:

-  Mode 1: Hibernation, where the heat pump is forced into standby. Standard mode is entered when continuous SG02 is in demand;
 -  Mode 2: Low energy mode with a maximum operating power of SG03 (when energy is insufficient or too expensive);
 -  Mode 3: Energy saving mode with maximum operating power SG04;
 -  Mode 4: Temperature Increasing Cooling/Heat Storage Mode. The heat pump target temp is raised according to SG05/SG06/SG07 and the electric heating is switched on according to SG08. (When energy consumption is low, the appliance can select a higher temp target to speed up heating and provide more domestic hot water);
 -  Normal Mode: Unit operates normally without power limitations and electric heater.
- To use the SG Ready function, press the “Parameters” key, enter the code “22” and select the number of contacts to be used (1 or 2) in the SG01 parameter.
 - The 1st contact (SG-1) is defined as Remote On/Off; the 2nd contact (SG-2) is defined as Remote Heating/Cooling Switch.

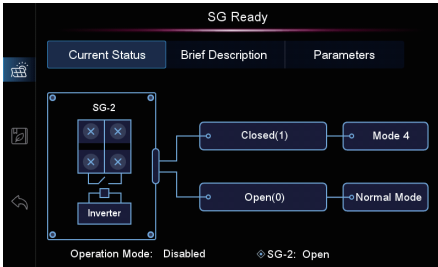

SG01=1

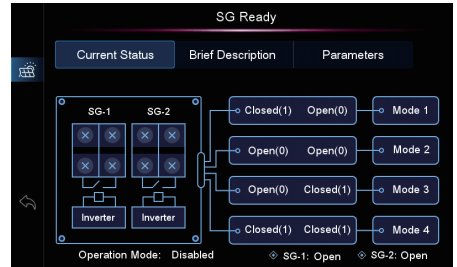

SG01=2

2.2 Auxiliary Heat function

Click the  button in the project interface to enter the auxiliary heat function interface.

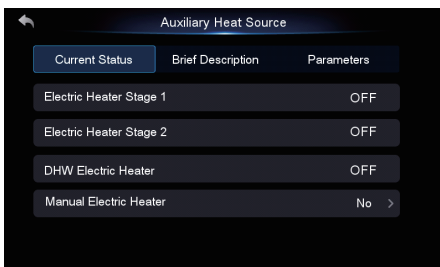

- Current Status: Displays three electric heating on/off states, and manual electric heating control parameters;
- Brief Description: Display the current AT. temp. and description of the conditions which the auxiliary heat source is turned on;
- To use the electric heater function, press the “Parameters” key, enter the code “22” and set the relevant parameters.

Operation and Use

2.3 Power timer function

Click the  button in the project interface to enter the power timer function interface.

This is the power on/off timer for the device. Up to 6 different timers are supported to adjust the operation of the device to your needs. Each timer allows you to select the number of days of the week that it will run.

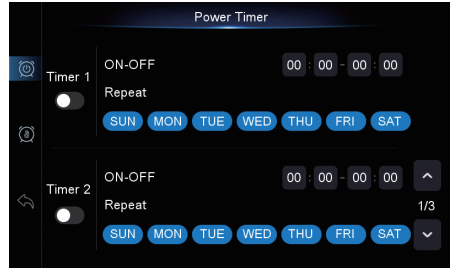

Remark:

The time is set in 24-hour format and supports hour and minute settings across days. Start and end times are set to the same time, timing is not effective.

2.4 Schedule function

Click the  button to enter the schedule function interface.

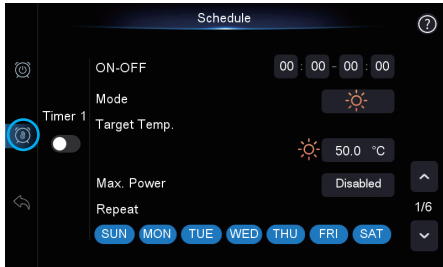

Support up to 6 different timers are supported to adjust the operation of the device to your needs. You can set the following:

- Start and end time
- Run mode
- Target temp
- Maximum power consumption
- Number of days the timer will run

2.5 Mute timer function

Click the  button in the project interface to enter the mute timer interface.

The Mute feature minimizes noise levels by limiting compressor and fan speeds.

Select the mute start time on the left side of the screen. Select the mute end time on the right side of the screen, which resumes normal operation.

Don't forget to activate the timer by pressing the switch on the right side of the screen.

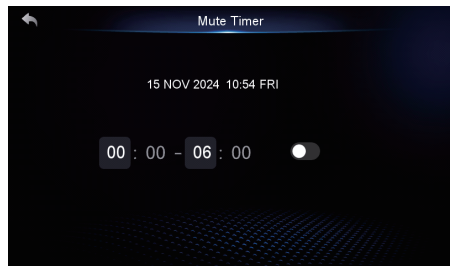

Remark:

If the mute function is not enabled, the timer mute setting is not available.

2.6 Unit state function

Click the  button in the project interface to enter customer function configuration menu.



Name	Description of operation
Unit Status	Turn the page to view all status parameters. Parameters are grouped by label according to the first letter of their code
Parameters	You can set some of the parameters according to the needs of the heat pump
Fault History	Record the unit's history of faults, and if a fault is manually cleared, the resolved faults will not appear in the fault log. The fault record has a power-down memory function
Manual Load Control	Manual load control, and can only be set in the off state
Unit Info	Display information about the device software
AT Compensation	Click to set the compensation according to the ambient temperature
R485 Config	Click to set the unit address

2.7 Brightness

Click the  button in the project interface to enter the mute timer interface.

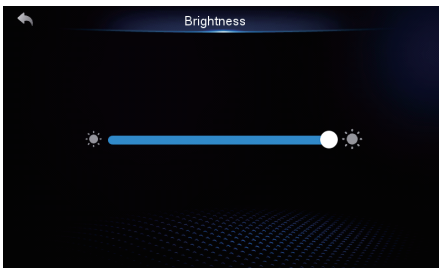

- Initialized brightness of 100, when the user set up after the set value to save, the next time the power or off the screen light according to the set brightness display.
- The screen will be darkened after 30s without operation, and then turn off the screen after 5min, and then light up after turning off the screen to return to the main interface.

3. Error Code Instruction

Protection/failure	Code	Cause	Solution
Water In Sensor Fault	P01	The sensor is damaged or there is a short circuit	<ol style="list-style-type: none"> 1.Check the connection to the main board. 2.Measure the resistance of the sensor. if lower than 100Ω or higher than 500Ω, replace the sensor.
Water Out Sensor Fault	P02		
Water Tank Temp Fault	P03		
AT Sensor Fault	P04		
Syst1: Suction Temp Sensor Fault	P17		
Syst2: Suction Temp Sensor Fault	P27		
Syst1: Exhaust Air Temp Sensor Fault	P181		
Syst2: Exhaust Air Temp Sensor Fault	P281		
Syst1: EVI(In) Temp Sensor Fault	P101		
Syst2: EVI(In) Temp Sensor Fault	P201		
Syst1: EVI(Out) Temp Sensor Fault	P102		
Syst2: EVI(Out) Temp Sensor Fault	P202		
Syst1: Antifreezing 1 Sensor Fault	P191		
Syst2: Antifreezing 1 Sensor Fault	P291		
Syst1: Coil Temp Sensor1 Fault	P150		
Syst1: Coil Temp Sensor2 Fault	P154		
Syst2: Coil Temp Sensor1 Fault	P250		
Syst2: Coil Temp Sensor2 Fault	P254		
Syst1: Coil(Out) Temp Sensor Fault	P152	The pressure sensor is damaged	<ol style="list-style-type: none"> 1.Check the pressure sensor connection. 2.If the connection is OK, replace the sensor.
Syst2: Coil(Out) Temp Sensor Fault	P252		
Syst1: Low Pressure Sensor Fault	PP11		
Syst2: Low Pressure Sensor Fault	PP21		
Syst1: High Pressure Sensor Fault	PP12	Exhaust temp ≥ 110 °C	<ol style="list-style-type: none"> 1.Measure the resistance of the sensor, if lower than 100Ω or higher than 500Ω, replace the sensor. 2.Check the unit find if it has refrigerant leakage.
Syst2: High Pressure Sensor Fault	PP22		
Syst1: Exhaust Air High Temp protection	P182	Exhaust temp ≥ 110 °C	<ol style="list-style-type: none"> 1.Measure the resistance of the sensor, if lower than 100Ω or higher than 500Ω, replace the sensor. 2.Check the unit find if it has refrigerant leakage.
Syst2: Exhaust Air High Temp protection	P282		

Operation and Use

Communication Fault	E08	Abnormal communication between wire controller and the main board	Inspect whether the wire controller, the main board and the connection thereof are reliable
The Wire Controller Does Not Match The Mainboard	E084	The mainboard software code is inconsistent with the setting	Normal operation, not affected
DC Fan Board 1 Communication Fault	E081	Communication of the speed regulation module 1 with main board is abnormal	Check the speed regulation module 1 and the main board and if their connections are normal and reliable
DC Fan Board 2 Communication Fault	E082	Communication of the speed regulation module 2 with main board is abnormal	Check the speed regulation module 2 and the main board and if their connections are normal and reliable
Syst1: High Pressure protection	E11	The pressure switch is damaged	1.Check the pressure sensor connection. 2.If the connection is OK, replace the sensor.
Syst2: High Pressure protection	E21		
Syst1: Low Pressure protection	E12		
Syst2: Low Pressure protection	E22		
Water Flow Switch protection	E032	The water system has no or only few water	Inspect whether the water flow of the water pipe conforms to related requirements and check the water pump for any damages
Electric Heater Overload protection	E04	Electric heating overheat protection switch is disconnected	Inspect whether the electric heating is under operation condition of over 150 °C for a long time
Primary Antifreezing protection In Winter	E19	Excessively low environment temperature	The environment temperature is more than 4 °C
Secondary Antifreezing protection in Winter	E29		
Syst1: Antifreezing protection	E171	The water in temp is low	1.Check the water temperature or change the temperature sensor 2.Check the water flow in the pipes and if there is a blockage.
Syst2: Antifreezing protection	E271		
Inlet and Outlet Water Abnormal protection	E064	Current inlet water temp and outlet water temp difference is too large	Check if the inlet and outlet water temperature sensor is working properly
Water(Out) High Temp protection	E065	Excessively high water outlet temperature	Adjust the outlet water temperature < Tprotect-10 °C
Fan 1 Thermal Overload protection	E103	Fan 1 thermal overload	Check if fan 1 is running normally
Fan 2 Thermal Overload protection	E203	Fan 2 thermal overload	Check if fan 2 is running normally
Water In/Out Large Temp Diff protection	E06	The water flow of the system is insufficient, the pressure difference of the water system is small	Inspect whether the water flow of the water pipe conforms to related requirements and check the water pump for any blockage
Water(Out) Low Temp protection	E071	Excessively low water outlet temperature	Adjust the outlet water temperature $\geq A24+8$ °C
Abnormal Power Fault	EE1	Power failure occurs on the home interface	The failure is cleared by the main control after 3 minutes
Syst1: 4-Way Valve Abnormal Switch	E121	The system 4-way valve switching failure	Check if the state of the 4-way valve switching direction is the desired state
Syst2: 4-Way Valve Abnormal Switch	E221		
Low Ambient Temp Not Allow Cooling	TC	Ambient temperature is too low to allow cooling	Check if the ambient temperature sensor is working properly
Low AT Power-Off Prot.	TP	Excessively low ambient temperature	Adjust the ambient temperature
Incorrect Fan Motor Model	O1W	The DC fan model is incorrect	Check that the DC fan model parameters are set correctly
Low Ambient Temp Shutdown protection	T4Q	Excessively low ambient temperature	Adjust the ambient temperature
R290 Concentration Detection Sensor 1 Communication Fault	C2F	Communication failure with R290 Concentration Detection Sensor 1	1. Check if the communication line is normal; 2. Check if the R290 Concentration Detection Sensor 1 is normal
R290 Concentration Detection Sensor 2 Communication Fault	C2G	Communication failure with R290 Concentration Detection Sensor 2	1. Check if the communication line is normal; 2. Check if the R290 Concentration Detection Sensor 2 is normal

Operation and Use

Syst1: The Inverter Board Communication Fault	F151	Communication failure with system 1 inverter board	1. Check if the communication line is normal; 2. Check if the system 1 inverter board is normal
Syst1: Comp. Start Fault	F152	System 1 compressor failed to start	1. Check if the compressor line is normal; 2. Check if the system 1 compressor is blocked
Syst1: Comp. Start IPM protection	F153	System 1 compressor starting current is too large	1. Check if the starting high pressure is excessive; 2. Check if the system 1 compressor is blocked
Syst1:Comp. Running IPM protection	F154	System 1 compressor running current is too large	Check if the pressure ratio is too high
Syst1: Comp. Overcurrent protection	F156	System 1 compressor running current is too large	Check if the pressure ratio is too high
Syst1:The Inverter Board IPM Over-Temp. protection	F155	System 1 compressor drive board has poor heat dissipation	Check if there is a gap in the installation of the fluorine-cooled heat sink
Syst1:The Inverter Board Bus Over Voltage protection	F157	Voltage is too high	Check if the input voltage is higher than 480V
Syst1:The Inverter Board Bus Under Voltage protection	F158	Voltage is too low	Check if the input voltage is lower than 250V
Syst2: The Inverter Board Communication Fault	F251	Communication failure with system 2 inverter board	1. Check if the communication line is normal; 2. Check if the system 2 inverter board is normal
Syst2: Comp. Start Fault	F252	System 2 compressor failed to start	1. Check if the compressor line is normal; 2. Check if the system 2 compressor is blocked
Syst2: Comp. Start IPM protection	F253	System 2 compressor starting current is too large	1. Check if the starting high pressure is excessive; 2. Check if the system 2 compressor is blocked
Syst2: Comp. Running IPM protection	F254	System 2 compressor running current is too large	Check if the pressure ratio is too high
Syst2: Comp. Overcurrent protection	F256	System 2 compressor running current is too large	Check if the pressure ratio is too high
Syst2:The Inverter Board IPM Over-Temp protection	F255	System 2 inverter board has poor heat dissipation	Check if there is a gap in the installation of the fluorine-cooled heat sink
Syst2:The Inverter Board Bus Over Voltage protection	F257	Voltage is too high	Check if the input voltage is higher than 480V
Syst2:The Inverter Board Bus Under Voltage protection	F258	Voltage is too low	Check if the input voltage is lower than 250V
DC Fan 1 Output Phase Loss protection	F101	System 1 fan failed to start	Check if the system 1 fan line is normal
DC Fan 1 Output Zero Speed protection	F102	System 1 fan failed to start	Check if the system 1 fan rotor is locked
DC Fan 1 Start IPM protection	F103	System 1 fan starting current is too large	Check if the system 1 fan rotor is locked
DC Fan 1 Running IPM protection	F104	System 1 fan running current is too large	Check if the system 1 fan rotor is locked
DC Fan 1 Overcurrent protection	F105	System 1 fan running current is too large	Check if the system 1 fan rotor is locked
DC Fan 1 Over-Temp protection	F106	System 1 fan drive board has poor heat dissipation	Check the heat dissipation condition
DC Fan 1 Bus Over Voltage protection	F107	Voltage is too high	Check if the input voltage is higher than 480V
DC Fan 1 Bus Under Voltage protection	F108	Voltage is too low	Check if the input voltage is lower than 250V
DC Fan 2 Output Phase Loss protection	F201	System 2 fan failed to start	Check if the system 2 fan line is normal
DC Fan 2 Output Zero Speed protection	F202	System 2 fan failed to start	Check if the system 2 fan rotor is locked
DC Fan 2 Start IPM protection	F203	System 2 fan starting current is too large	Check if the system 2 fan rotor is locked
DC Fan 2 Running IPM protection	F204	System 2 fan running current is too large	Check if the system 2 fan rotor is locked
DC Fan 2 Overcurrent protection	F205	System 2 fan running current is too large	Check if the system 2 fan rotor is locked

Operation and Use

DC Fan 2 Over-Temp protection	F206	System 2 fan drive board has poor heat dissipation	Check the heat dissipation condition
DC Fan 2 Bus Over Voltage protection	F207	Voltage is too high	Check if the input voltage is higher than 480V
DC Fan 2 Bus Under Voltage protection	F208	Voltage is too low	Check if the input voltage is lower than 250V
DC Fan Motor 1 Current Sampling Fault	F112	The current sampling of fan 1 is abnormal	Check if the system 1 fan rotor is locked
DC Fan Motor 2 Current Sampling Fault	F212	The current sampling of fan 2 is abnormal	Check if the system 2 fan rotor is locked
DC Fan Motor 1 Overspeed Protection	F109	The fan speed of system 1 is too high	Check if the system 1 fan rotor is locked
DC Fan Motor 2 Overspeed Protection	F209	The fan speed of system 2 is too high	Check if the system 2 fan rotor is locked
DC Fan Motor 1 Lowspeed Protection	F110	The fan speed of system 1 is incorrect	Check if the system 1 fan rotor is locked
DC Fan Motor 2 Lowspeed Protection	F210	The fan speed of system 2 is incorrect	Check if the system 2 fan rotor is locked
Compressor Type Error	F088	The compressor model is incorrect	Check if the compressor model parameters are consistent with the corresponding model
Syst1: Water In Sensor Fault	T5U	The sensor is damaged or there is a short circuit	1.Check the connection to the main board. 2.Measure the resistance of the sensor. if lower than 100Ω or higher than 500Ω, replace the sensor.
Syst2: Water In Sensor Fault	T5V		
Syst1: Water Out Sensor Fault	T5W		
Syst2: Water Out Sensor Fault	T5X		
Buffer Tank Temp. Sensor Fault	T5D		
System 1 Overhigh Outlet Water Temp.	T6A	Excessively high water outlet temperature	Adjust the outlet water temperature < Tprotect-10 C
System 2 Overhigh Outlet Water Temp.	T6B		
System 1 Low Outlet Water Temp. Fault	T6C	Excessively low water outlet temperature	Adjust the outlet water temperature ≥A24+8 C
System 2 Low Outlet Water Temp. Fault	T6D		
Syst1: Low Water Flow Protection	S1G	Water flow is too low	Increased water flow
Syst2: Low Water Flow Protection	S1H		
Water Flow Switch2 protection	D2P	The water system has no or only few water	Inspect whether the water flow of the water pipe conforms to related requirements and check the water pump for any damages
Communication Fault with Consumption Module	E083	Abnormal communication between the consumption module and the main board	Check if the consumption module line is normal
Syst1: Flowmeter communication Fault	C2P	Abnormal communication between the flowmeter and the main board	Check if the flowmeter line is normal
Syst2: Flowmeter communication Fault	C2Q		

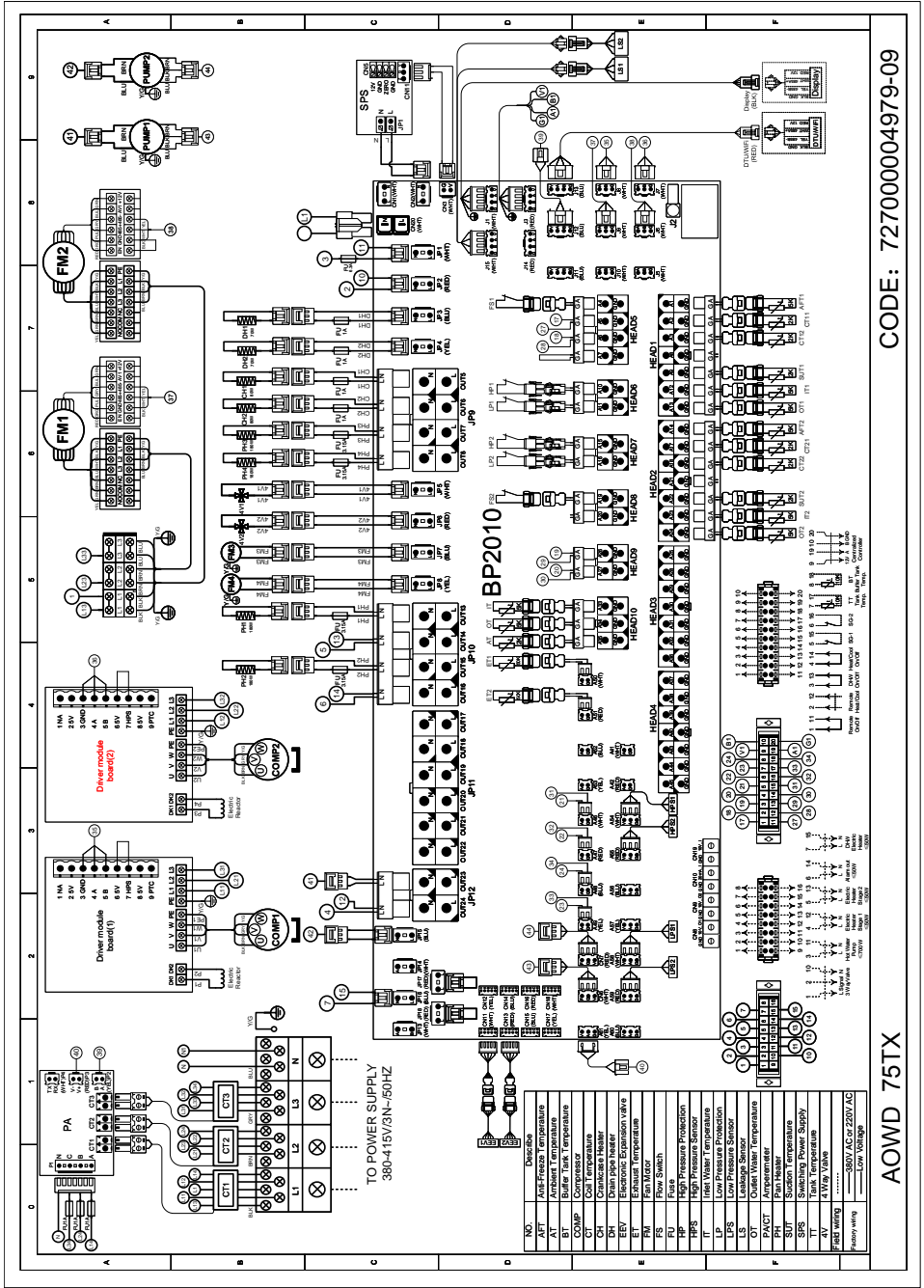

NO.	Describe
AFT	Air-Freeze Temperature
BT	Ball Temperature
BT	Ball Tank Temperature
COMP	Compressor
CT	Coil Temperature
CS	Control Switch
CS	Chamber Sensor
CS	Chamber Sensor
EY	Electronic Expansion Valve
ET	Exhaust Temperature
FM	Fan Motor
FN	Fan Switch
FU	Fuse
HP	High-Pressure Protection
RPS	High-Pressure Sensor
LP	Low-Pressure Protection
LPS	Low-Pressure Sensor
LS	Leakage Sensor
MT	Medium-Temperature
PACT	Pressure Actuator
PH	Pressure Head
SUF	Subcooling
SPS	Switching Power Supply
TR	Temperature
TV	4-1/8" Valve
TV	4-1/8" Valve

CODE: 72700004979-09

AOWD 75TX

Operation and Use

The input and output interface instructions

No.	Sign	Meaning	No.	Sign	Meaning
1	A1	Syst1: Antifreezing Temp	41	A41	Syst1: Fan Overload Prot.
2	A2	Syst1: Coil Temp 1	42	A42	Syst2: Fan Overload Prot.
3	A3	Syst1: Coil Temp 2	43	A43	Reserved
4	A4	Water Flow Switch	44	A44	Reserved
5	A5	Emergency Input	45	A45	Reserved
6	A6	Mode	46	A46	SG-1
7	A7	Electric Heater Overload Prot.	47	A47	SG-2
8	A8	Syst1: Outlet(Coil) Temp	48	A48	Buffer Tank Temp.
9	A9	Syst1: Suction Temp	49	A49	WaterTank Temp
10	A10	Syst1: HP Switch	50	A50	Syst1: Exhaust Air Temp
11	A11	Syst1: LP Switch	51	A51	Syst2: Exhaust Air Temp
12	A12	Syst1: Inlet(Water) Temp	52	A52	Reserved
13	A13	Syst1: Outlet(Water) Temp	53	A53	Reserved
14	A14	Syst2: Antifreezing Temp	54	A54	Syst1: High Pressure
15	A15	Syst2: HP Switch	55	A55	Syst2: High Pressure
16	A16	Syst2: LP Switch	56	A56	Transformer Current 1
17	A17	Syst2: Coil Temp 1	57	A57	Transformer Current 2
18	A18	Syst2: Coil Temp 2	58	A58	Syst1: Low Pressure
19	A19	Water Flow Switch2	59	A59	Syst2: Low Pressure
20	A20	Reserved	60	A60	Transformer Current 3
21	A21	Syst2: Outlet(Coil) Temp	61	A61	Reserved
22	A22	Syst2: Suction Temp	62	CN1	220V input
23	A23	Syst2: Inlet(Water) Temp	63	CN2	220V output
24	A24	Syst2: Outlet(Water) Temp	64	CN3	12V input
25	A25	Reserved	65	CN4	PCIe DTU
26	A26	Reserved	66	CN5	Expansion Board
27	A27	Reserved	67	CN6	Pump Speed Control Feedback 1
28	A28	Reserved	68	CN7	Pump Speed Control Feedback 2
29	A29	Reserved	69	CN8	Reserved
30	A30	Reserved	70	CN9	Reserved
31	A31	Reserved	71	CN10	Reserved
32	A32	Reserved	72	CN11	Syst1: EEV Big Valve
33	A33	Inlet(Water) Temp	73	CN12	Reserved
34	A34	Outlet(Water) Temp	74	CN13	Syst2: EEV Big Valve
35	A35	Ambient Temperature	75	CN14	Syst2: EVI EEV Valve
36	A36	Reserved	76	CN15	Syst1: EVI EEV Valve
37	A37	Reserved	77	CN16	Syst2: EEV Small Valve
38	A38	Reserved	78	CN17	Reserved
39	A39	Reserved	79	CN18	Syst1: EEV Small Valve
40	A40	Reserved	80	CN19	Reserved

Operation and Use

No.	Sign	Meaning	No.	Sign	Meaning
81	CN23	Reserved	99	OUT13	Syst1:Drain Pan Heating Cable
82	CN300	Program port	100	OUT14	Electric Heater Stage 2
83	J1/J15	Wire controller /R290 gas sensor 1/2	101	OUT15	Syst1:Drain Pan Heating Cable
84	J3/J14	Centralized controller communication port	102	OUT16	Alarm
85	J11/J12 /J13	DTU/Consumption Module/ Flowmeter 1/Flowmeter 2	103	OUT17	Syst1: Fan low speed
86	J5/J6/ J7/J8/ J9/J10	Compressor inverter board 1/2/DC fan board 1	104	OUT18	Syst1: Fan high speed
87	OUT1	DHW Pump	105	OUT19	Syst1: Fan high speed 2
88	OUT2	3-way Valve	106	OUT20	Syst1: Fan low speed
89	OUT3	Drain Pan Heating Cable	107	OUT21	Syst1: Fan high speed
90	OUT4	Drain Pan Heating Cable	108	OUT22	Syst1: Fan high speed 2
91	OUT5	Syst1: Crankshaft Heater	109	OUT23	Circulating Pump
92	OUT6	Syst2: Crankshaft Heater	110	OUT24	Electric Heater Stage 1
93	OUT7	Syst2:Drain Pan Heating Cable	111	JP15	Circulating Pump 2
94	OUT8	Syst2:Drain Pan Heating Cable	112	JP14	Reserved
95	OUT9	Syst1:4-Way Valve	113	JP16	DHW Auxiliary Heater
96	OUT10	Syst2:4-Way Valve	114	JP13	Reserved
97	OUT11	Exhaust fan 1	115	JP17	Short circuit
98	OUT12	Exhaust fan 2	116	JP18	Short circuit

Maintenance and Inspection

- Check the water supply device and the release often. You should avoid the condition of no water or air entering into system, as this will influence unit's performance and reliability. You should clear the heat pump filter regularly to avoid damage to the unit as a result of the dirty of clogged filter.
- The area around the unit should be dry, clean and well ventilated. Clean the side heating exchanger regularly to maintain good heat exchange as conserve energy .
- The operation pressure of the refrigerant system should only be serviced by a certified technician .
- Check the power supply and cable connection often,.Should the unit begin to operate abnormally, switch it off and contact the qualified technician.
- Discharge all water in the water pump and water system ,so that freezing of the water in the pump or water system does not occur. You should discharge the water at the bottom of water pump if the unit will not be used for an extended period of time. You should check the unit thoroughly and fill the system with water fully before using it for the first time after a
- Checks to the area
Prior to beginning work on systems containing flammable refrigerants, safety checks are necessary to ensure that the risk of ignition is minimised. For repair to the refrigerating system, the following precautions shall be complied with prior to conducting work on the system. prolonged period of no usage.
- Work procedure
Work shall be undertaken under a controlled procedure so as to minimise the risk of a flammable gas or vapour being present while the work is being performed.
- General work area
All maintenance staff and others working in the local area shall be instructed on the nature of work being carried out. Work in confined spaces shall be avoided. The area around the workspace shall be sectioned off. Ensure that the conditions within the area have been made safe by control of flammable material.
- Checking for presence of refrigerant
The area shall be checked with an appropriate refrigerant detector prior to and during work, to ensure the technician is aware of potentially flammable atmospheres. Ensure that the leak detection equipment being used is suitable for use with flammable refrigerants, i.e. non-sparking, adequately sealed or intrinsically safe.
- Presence of fire extinguisher
If any hot work is to be conducted on the refrigeration equipment or any associated parts, appropriate fire extinguishing equipment shall be available to hand. Have a dry powder or CO2 fire extinguisher adjacent to the charging area.

Maintenance and Inspection

● No ignition sources

No person carrying out work in relation to a refrigeration system which involves exposing any pipe work that contains or has contained flammable refrigerant shall use any sources of ignition in such a manner that it may lead to the risk of fire or explosion. All possible ignition sources, including cigarette smoking, should be kept sufficiently far away from the site of installation, repairing, removing and disposal, during which flammable refrigerant can possibly be released to the surrounding space. Prior to work taking place, the area around the equipment is to be surveyed to make sure that there are no flammable hazards or ignition risks. “No Smoking” signs shall be displayed.

● Ventilated area

Ensure that the area is in the open or that it is adequately ventilated before breaking into the system or conducting any hot work. A degree of ventilation shall continue during the period that the work is carried out. The ventilation should safely disperse any released refrigerant and preferably expel it externally into the atmosphere. prolonged period of no usage.

● Checks to the refrigeration equipment

Where electrical components are being changed, they shall be fit for the purpose and to the correct specification. At all times the manufacturer's maintenance and service guidelines shall be followed. If in doubt consult the manufacturer's technical department for assistance.

The following checks shall be applied to installations using flammable refrigerants:

The charge size is in accordance with the room size within which the refrigerant containing parts are installed;

The ventilation machinery and outlets are operating adequately and are not obstructed;

If an indirect refrigerating circuit is being used, the secondary circuit shall be checked for the presence of refrigerant;

Marking to the equipment continues to be visible and legible. Markings and signs that are illegible shall be corrected;

Refrigeration pipe or components are installed in a position where they are unlikely to be exposed to any substance which may corrode refrigerant containing components, unless the components are constructed of materials which are inherently resistant to being corroded or are suitably protected against being so corroded.

● Checks to electrical devices

Repair and maintenance to electrical components shall include initial safety checks and component inspection procedures. If a fault exists that could compromise safety, then no electrical supply shall be connected to the circuit until it is satisfactorily dealt with. If the fault cannot be corrected immediately but it is necessary to continue operation, an adequate temporary solution shall be used. This shall be reported to the owner of the equipment so all parties are advised.

Initial safety checks shall include:

. That capacitors are discharged: this shall be done in a safe manner to avoid possibility of sparking;

. That there no live electrical components and wiring are exposed while charging, recovering or purging the system;

. That there is continuity of earth bonding.

Maintenance and Inspection

● Repairs to sealed components

1) During repairs to sealed components, all electrical supplies shall be disconnected from the equipment being worked upon prior to any removal of sealed covers, etc. If it is absolutely necessary to have an electrical supply to equipment during servicing, then a permanently operating form of leak detection shall be located at the most critical point to warn of a potentially hazardous situation.

2) Particular attention shall be paid to the following to ensure that by working on electrical components, the casing is not altered in such a way that the level of protection is affected. This shall include damage to cables, excessive number of connections, terminals not made to original specification, damage to seals, incorrect fitting of glands, etc.

Ensure that apparatus is mounted securely.

Ensure that seals or sealing materials have not degraded such that they no longer serve the purpose of preventing the ingress of flammable atmospheres. Replacement parts shall be in accordance with the manufacturer's specifications.

NOTE: The use of silicon sealant may inhibit the effectiveness of some types of leak detection equipment. Intrinsically safe components do not have to be isolated prior to

● Repair to intrinsically safe components

Do not apply any permanent inductive or capacitance loads to the circuit without ensuring that this will not exceed the permissible voltage and current permitted for the equipment in use.

Intrinsically safe components are the only types that can be worked on while live in the presence of a flammable atmosphere. The test apparatus shall be at the correct rating.

Replace components only with parts specified by the manufacturer. Other parts may result in the ignition of refrigerant in the atmosphere from a leak.

● Cabling

Check that cabling will not be subject to wear, corrosion, excessive pressure, vibration, sharp edges or any other adverse environmental effects. The check shall also take into account the effects of aging or continual vibration from sources such as compressors or fans.

● Detection of flammable refrigerants

Under no circumstances shall potential sources of ignition be used in the searching for or detection of refrigerant leaks. A halide torch (or any other detector using a naked flame) shall not be used.

● Leak detection methods

The following leak detection methods are deemed acceptable for systems containing flammable refrigerants.

Electronic leak detectors shall be used to detect flammable refrigerants, but the sensitivity may not be adequate, or may need re-calibration. (Detection equipment shall be calibrated in a refrigerant-free area.) Ensure that the detector is not a potential source of ignition and is suitable for the refrigerant used. Leak detection equipment shall be set at a percentage of the LFL of the refrigerant and shall be calibrated to the refrigerant employed and the appropriate percentage of gas (25 % maximum) is confirmed.

Leak detection fluids are suitable for use with most refrigerants but the use of detergents containing chlorine shall be avoided as the chlorine may react with the refrigerant and corrode the copper pipe-work.

If a leak is suspected, all naked flames shall be removed/ extinguished.

If a leakage of refrigerant is found which requires brazing, all of the refrigerant shall be recovered from the system, or isolated (by means of shut off valves) in a part of the system remote from the leak. Oxygen free nitrogen (OFN) shall then be purged through the system both before and during the brazing process.

Maintenance and Inspection

● Removal and evacuation

When breaking into the refrigerant circuit to make repairs or for any other purpose conventional procedures shall be used. However, it is important that best practice is followed since flammability is a consideration. The following procedure shall be adhered to:

- . Remove refrigerant;
- . Purge the circuit with inert gas;
- . Evacuate;
- . Purge again with inert gas;
- . Open the circuit by cutting or brazing.

The refrigerant charge shall be recovered into the correct recovery cylinders. The system shall be "flushed" with OFN to render the unit safe. This process may need to be repeated several times. Compressed air or oxygen shall not be used for this task.

Flushing shall be achieved by breaking the vacuum in the system with OFN and continuing to fill until the working pressure is achieved, then venting to atmosphere, and finally pulling down to a vacuum. This process shall be repeated until no refrigerant is within the system.

When the final OFN charge is used, the system shall be vented down to atmospheric pressure to enable work to take place. This operation is absolutely vital if brazing operations on the pipe-work are to take place.

Ensure that the outlet for the vacuum pump is not close to any ignition sources and there is ventilation available. working on them.

● Labelling

Equipment shall be labelled stating that it has been de-commissioned and emptied of refrigerant. The label shall be dated and signed. Ensure that there are labels on the equipment stating the equipment contains flammable refrigerant.

● Recovery

When removing refrigerant from a system, either for servicing or decommissioning, it is recommended good practice that all refrigerants are removed safely.

When transferring refrigerant into cylinders, ensure that only appropriate refrigerant recovery cylinders are employed. Ensure that the correct number of cylinders for holding the total system charge is available. All cylinders to be used are designated for the recovered refrigerant and labelled for that refrigerant (i.e. special cylinders for the recovery of refrigerant). Cylinders shall be complete with pressure relief valve and associated shut-off valves in good working order. Empty recovery cylinders are evacuated and, if possible, cooled before recovery occurs.

The recovery equipment shall be in good working order with a set of instructions concerning the equipment that is at hand and shall be suitable for the recovery of flammable refrigerants. In addition, a set of calibrated weighing scales shall be available and in good working order. Hoses shall be complete with leak-free disconnect couplings and in good condition. Before using the recovery machine, check that it is in satisfactory working order, has been properly maintained and that any associated electrical components are sealed to prevent ignition in the event of a refrigerant release. Consult manufacturer if in doubt.

The recovered refrigerant shall be returned to the refrigerant supplier in the correct recovery cylinder, and the relevant Waste Transfer Note arranged. Do not mix refrigerants in recovery units and especially not in cylinders.

If compressors or compressor oils are to be removed, ensure that they have been evacuated to an acceptable level to make certain that flammable refrigerant does not remain within the lubricant. The evacuation process shall be carried out prior to returning the compressor to the suppliers. Only electric heating to the compressor body shall be employed to accelerate this process. When oil is drained from a system, it shall be carried out safely.

Maintenance and Inspection

● Decommissioning

Before carrying out this procedure, it is essential that the technician is completely familiar with the equipment and all its detail. It is recommended good practice that all refrigerants are recovered safely. Prior to the task being carried out, an oil and refrigerant sample shall be taken in case analysis is required prior to re-use of reclaimed refrigerant. It is essential that electrical power is available before the task is commenced.

- a) Become familiar with the equipment and its operation.
- b) Isolate system electrically.
- c) Before attempting the procedure ensure that:
 - . Mechanical handling equipment is available, if required, for handling refrigerant cylinders;
 - . All personal protective equipment is available and being used correctly;
 - . The recovery process is supervised at all times by a competent person;
 - . Recovery equipment and cylinders conform to the appropriate standards.
- d) Pump down refrigerant system, if possible.
- e) If a vacuum is not possible, make a manifold so that refrigerant can be removed from various parts of the system.
- f) Make sure that cylinder is situated on the scales before recovery takes place.
- g) Start the recovery machine and operate in accordance with manufacturer's instructions.
- h) Do not overfill cylinders. (No more than 80 % volume liquid charge).
- i) Do not exceed the maximum working pressure of the cylinder, even temporarily.
- j) When the cylinders have been filled correctly and the process completed, make sure that the cylinders and the equipment are removed from site promptly and all isolation valves on the equipment are closed off.
- k) Recovered refrigerant shall not be charged into another refrigeration system unless it has been cleaned and checked.

● Charging procedures

In addition to conventional charging procedures, the following requirements shall be followed.

- Ensure that contamination of different refrigerants does not occur when using charging equipment. Hoses or lines shall be as short as possible to minimise the amount of refrigerant contained in them.
- Cylinders shall be kept upright.
- Ensure that the refrigeration system is earthed prior to charging the system with refrigerant.
- Label the system when charging is complete (if not already).
- Extreme care shall be taken not to overfill the refrigeration system.

Prior to recharging the system it shall be pressure tested with OFN. The system shall be leak tested on completion of charging but prior to commissioning. A follow up leak test shall be carried out prior to leaving the site.

Appendix

Appendix 1、 Caution & Warning

1. The unit can only be repaired by qualified installer centre personnel or an authorised dealer. (for Europe market)
2. This appliance is not intended for use by persons (including children) with reduced physical sensory or mental capabilities, or lack of experience and knowledge, unless they have been given supervision or instruction concerning use of the appliance by a person responsible for their safety. (for Europe market)
Children should be supervised to ensure that they do not play with the appliance.
3. Please make sure that the unit and power connection have good earthing, otherwise may cause electrical shock.
4. If the supply cord is damaged, it must be replaced by the manufacturer or our service agent or similarly qualified person in order to avoid a hazard.
5. Directive 2002/96/EC (WEEE):
The symbol depicting a crossed-out waste bin that is underneath the appliance indicates that this product, at the end of its useful life, must be handled separately from domestic waste, must be taken to a recycling centre for electric and electronic devices or handed back to the dealer when purchasing an equivalent appliance.
6. Directive 2002/95/EC (RoHs): This product is compliant with directive 2002/95/EC (RoHs) concerning restrictions for the use of harmful substances in electric and electronic devices.
7. The unit CANNOT be installed near the flammable gas. Once there is any leakage of the gas , fire can be occur.
8. Make sure that there is circuit breaker for the unit, lack of circuit breaker can lead to electrical shock or fire.
9. The heat pump located inside the unit is equipped with an over-load protection system. It does not allow for the unit to start for at least 3 minutes from a previous stoppage.
10. The unit can only be repaired by the qualified personnel of an installer center or an authorized dealer. (for North America market)
11. Installation must be performed in accordance with the NEC/CEC by authorized person only. (for North America market)
12. USE SUPPLY WIRES SUITABLE FOR 75°C.
13. Caution: Single wall heat exchanger, not suitable for potable water connection.

Appendix

Appendix 2、Cable specification

1. Single phase unit

Nameplate maximum current	Phase line	Earth line	MCB	Creepage protector	Signal line
No more than 10A	$2 \times 1.5\text{mm}^2$	1.5mm^2	20A	30mA less than 0.1 sec	$n \times 0.5\text{mm}^2$
10~16A	$2 \times 2.5\text{mm}^2$	2.5mm^2	32A	30mA less than 0.1 sec	
16~25A	$2 \times 4\text{mm}^2$	4mm^2	40A	30mA less than 0.1 sec	
25~32A	$2 \times 6\text{mm}^2$	6mm^2	40A	30mA less than 0.1 sec	
32~40A	$2 \times 10\text{mm}^2$	10mm^2	63A	30mA less than 0.1 sec	
40~63A	$2 \times 16\text{mm}^2$	16mm^2	80A	30mA less than 0.1 sec	
63~75A	$2 \times 25\text{mm}^2$	25mm^2	100A	30mA less than 0.1 sec	
75~101A	$2 \times 25\text{mm}^2$	25mm^2	125A	30mA less than 0.1 sec	
101~123A	$2 \times 35\text{mm}^2$	35mm^2	160A	30mA less than 0.1 sec	
123~148A	$2 \times 50\text{mm}^2$	50mm^2	225A	30mA less than 0.1 sec	
148~186A	$2 \times 70\text{mm}^2$	70mm^2	250A	30mA less than 0.1 sec	
186~224A	$2 \times 95\text{mm}^2$	95mm^2	280A	30mA less than 0.1 sec	

2. Three phase unit

Nameplate maximum current	Phase line	Earth line	MCB	Creepage protector	Signal line
No more than 10A	$3 \times 1.5\text{mm}^2$	1.5mm^2	20A	30mA less than 0.1 sec	$n \times 0.5\text{mm}^2$
10~16A	$3 \times 2.5\text{mm}^2$	2.5mm^2	32A	30mA less than 0.1 sec	
16~25A	$3 \times 4\text{mm}^2$	4mm^2	40A	30mA less than 0.1 sec	
25~32A	$3 \times 6\text{mm}^2$	6mm^2	40A	30mA less than 0.1 sec	
32~40A	$3 \times 10\text{mm}^2$	10mm^2	63A	30mA less than 0.1 sec	
40~63A	$3 \times 16\text{mm}^2$	16mm^2	80A	30mA less than 0.1 sec	
63~75A	$3 \times 25\text{mm}^2$	25mm^2	100A	30mA less than 0.1 sec	
75~101A	$3 \times 25\text{mm}^2$	25mm^2	125A	30mA less than 0.1 sec	
101~123A	$3 \times 35\text{mm}^2$	35mm^2	160A	30mA less than 0.1 sec	
123~148A	$3 \times 50\text{mm}^2$	50mm^2	225A	30mA less than 0.1 sec	
148~186A	$3 \times 70\text{mm}^2$	70mm^2	250A	30mA less than 0.1 sec	
186~224A	$3 \times 95\text{mm}^2$	95mm^2	280A	30mA less than 0.1 sec	

When the unit will be installed at outdoor, please use the cable which can against UV.

dzitsu

EUROFRED
being efficient

Eurofred S.A.
Marqués de Sentmenat 97
08029 Barcelona
www.eurofred.es