

SERVICE INSTRUCTIONS

FR10 *3013L*
30661050 *30662050*
1070 *2070*

SPLIT TYPE ROOM
AIR CONDITIONER

WALL MOUNTED
COMPACT-M2 type

9000 BTU/H
12000 BTU/H

WIRELESS REMOTE
CONTROL MODEL

CONTENTS

DIMENSIONS	1
DESCRIPTION OF FUNCTIONS	2
DEFROSTING OPERATION FLOW CHART	9
TROUBLESHOOTING	10
PRECAUTIONS ON INSTALLATION	13

D I M E N S I O N S

9000, 12000 BTU/h Models

Unit: mm

1. INDOOR UNIT

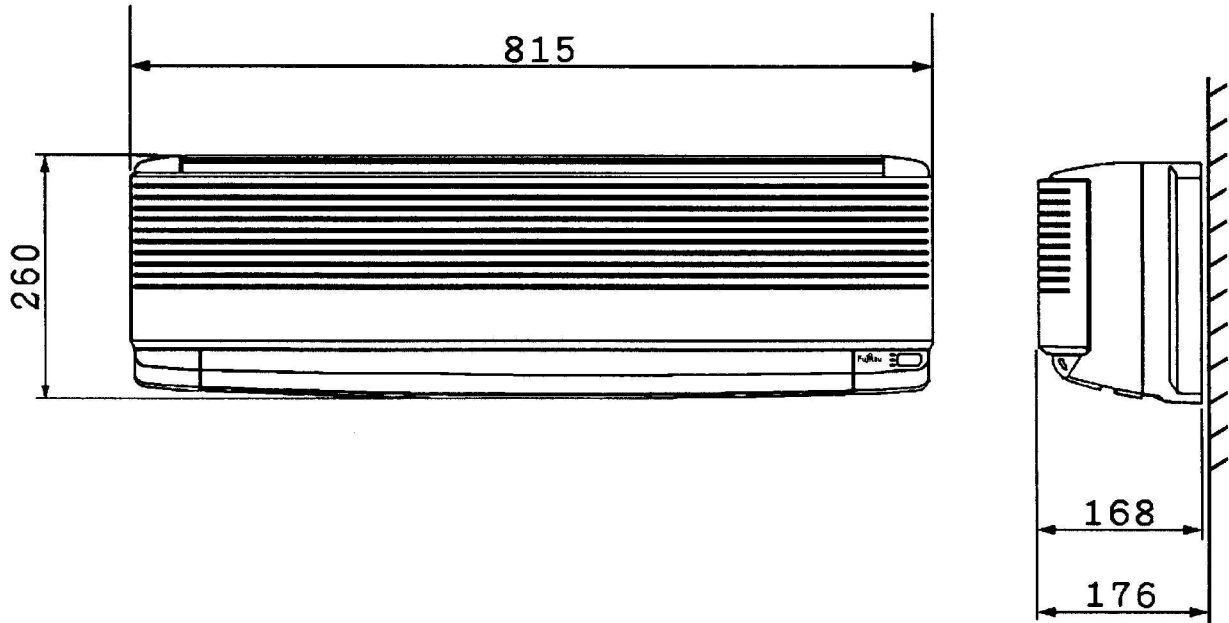

2. OUTDOOR UNIT

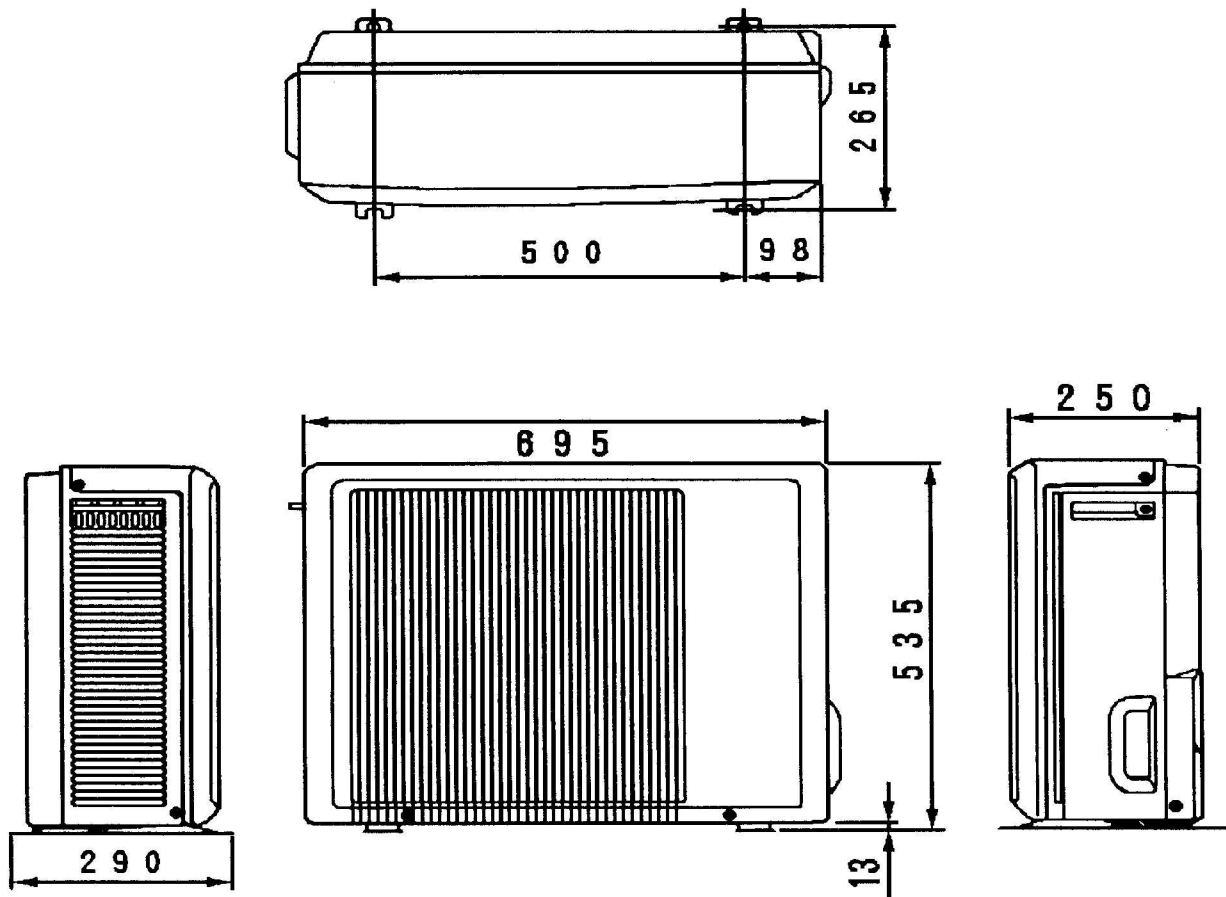

DESCRIPTION OF FUNCTIONS

1. THREE MINUTES DELAY FUNCTION (3ST)

- 1) The outdoor unit does not operate for three minutes after the power switch is turned on. (Compressor protection, breaker off prevention, etc.)
- 2) When test operation is performed in heating during continuous operation, it takes some time until an air blows out of the indoor unit because "Three minutes delay" and "Cold air prevention" have priority over TEST operation.

2. THREE MINUTES CONTINUOUS OPERATION TIMER (3HT)

The unit continues to run without halting for three minutes after the compressor starts.

3. INDOOR HEAT EXCHANGER DE-ICING FUNCTION (When cooling & dry operating)

• Cooling operation

When the temperature of the heat exchanger on the indoor side becomes less than 3°C during cooling operation, FAN CONTROL is switched to HIGH flow automatically. After that, when the temperature of the indoor heat exchanger becomes 7°C or more, fan control returns to the air flow specified.

When the temperature of the indoor heat exchanger is kept less than 3°C for 3 minutes at HIGH flow, the compressor stops.

• Dry operation

When the temperature of the heat exchanger becomes more than 13°C at the time of the operation start, the compressor starts once.

But, the heat exchanger is under 13°C, and the compressor does not start before the THREE MINUTES DELAY (3ST) function finishes.

When the temperature of the heat exchanger is under 3°C at the time of the compressor stop, the indoor fan motor continues to operate until the THREE MINUTES DELAY (3ST) function finishes.

4. DEFROSTING OPERATION [REVERSE CYCLE] See Defrosting Flow Chart on page 9.

- 1) The defrosting operation is performed when frost is produced on the outdoor heat exchanger. At this time, the heating mode will stop temporarily.
- 2) The defrosting operation time differs from conditions such as temperature, humidity, etc.. (Approximately 7 to 15 minutes)
- 3) During the defrosting operation, both indoor and outdoor fans stop and the operation lamp flashes.
- 4) "Bushhhh", "goh, goh, goh", and other sounds will be heard during the defrosting operation. These sounds are normal. (Four-way valve switching sound, refrigerant sound)

5. 4-WAY VALVE DELAY SWITCHING FUNCTION [REVERSE CYCLE]

When heat operation stops, 4-way valve stops 3 minutes later.

6. COLD AIR DISCHARGE PREVENTION FUNCTION [REVERSE CYCLE]

- 1) When heat operation starts, the indoor unit fan operates by the "S-Lo(Super-Low)" mode even in any case. After the temperature of the indoor heat exchanger becomes more than 27°C, operation enters into the air flow mode specified.
- 2) When the compressor stops by the thermostat, the indoor fan S-Lo mode about 15 seconds later.

7. HEATING OVERLOAD PROTECTION FUNCTION [REVERSE CYCLE]

During heating operation, the compressor operates, but the outdoor fan may stop. A function which suppresses the absorption of heat and protects the machine by stopping the outdoor fan when the indoor heat exchanger temperature has risen abnormally and the outdoor temperature is high, is provided.

- 1) When the indoor heat exchanger temperature reaches 55°C, the outdoor fan motor stops.
- 2) When the indoor heat exchanger temperature has recovered to 50°C, the outdoor fan motor starts.
- 3) When the indoor heat exchanger temperature rises to 59°C, the compressor stops even when the outdoor fan motor stops.

8. SET TEMPERATURE COMPENSATION AT OPERATION START

At the time of operation start and when MASTER CONTROL is switched to cooling and heating, the set temperatures are compensated by +2°C for heat operation for 60 min. and by -1°C for cool operation for 40 min.

9. OPERATION CONTROL PANEL AND REMOTE CONTROL UNIT BUTTON

OPERATION CONTROL PANEL

① POWER SWITCH

ON : During normal operation, leave in this position.

OFF: Set to this position when not using the unit for an extended period of time.

② MANUAL AUTO BUTTON

Use this button for temporary manual operation in the event that the remote control unit batteries die, or the remote control unit is lost. The operation is the same as MASTER CONTROL "AUTO" position. In order to halt operation, either push the forcing automatic button again or turn POWER SWITCH off.

— Operation Control Panel —

Controls are located under the front panel

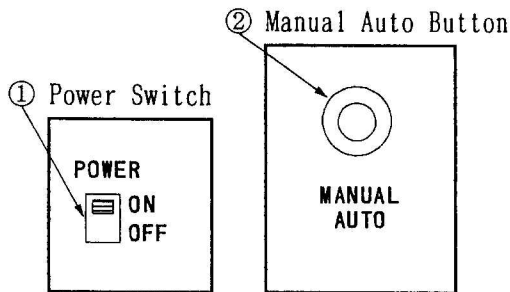

③ "TEST" BUTTON (TEST position)

- (1) When switched to the "TEST" position, only the thermostat is short-circuited.
- (2) Set to this position when testing after installation.
- (3) If the air conditioner is used in the "TEST" state, since the compressor, heat exchanger, etc. will be damaged because the temperature control can not be performed, always be switched to "NORMAL" operation.
- (4) If the microcomputer or other electronic circuit is faulty, the air conditioner can not be operated even by the test run.
- (5) The "TEST" operation mode is released after 60 minutes and then the unit is set to "Normal" operation.

— Remote control unit —

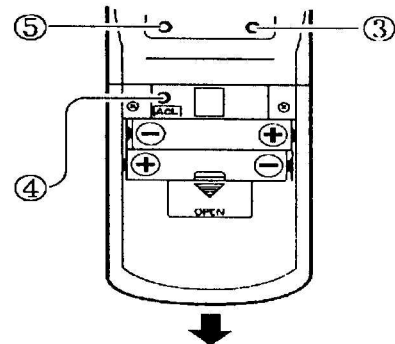
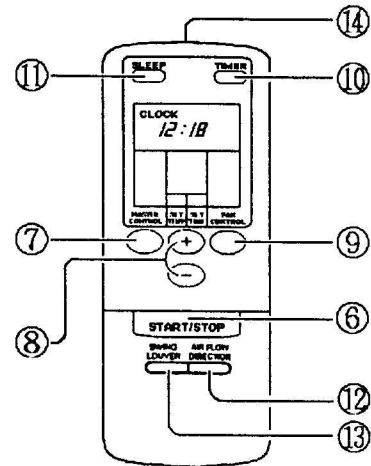

- ③ TEST RUN button
- ④ ACL button
- ⑤ TIME ADJUSTMENT button
- ⑥ START/STOP button
- ⑦ MASTER CONTROL button
- ⑧ SET TEMP./SET TIME buttons
- ⑨ FAN CONTROL button
- ⑩ TIMER button
- ⑪ SLEEP button
- ⑫ AIRFLOW DIRECTION button
- ⑬ SWING LOUVER button
- ⑭ Signal Transmitter

④ "ACL" BUTTON

- (1) Press and slide the battery compartment lid on the reverse side to open it.
- (2) Insert batteries.
- (3) Press the ACL button.
- (4) Close the battery compartment lid.

NOTE: Never mix new batteries with used ones, or batteries of different types. Batteries will last about one year under normal use. If the remote control unit operating range becomes appreciably reduced, replace the batteries and press the ACL button with the tip of a ball-point pen or other small object.

⑤ "TIME ADJUSTMENT" BUTTON

- (1) Press the TIME ADJUSTMENT button.
- (2) Use the +/- SET TIME buttons to adjust the clock to the current time.
- (3) Press the TIME ADJUSTMENT button again.

⑥ START/STOP AND ⑦ MASTER CONTROL BUTTONS

- (1) Press the START/STOP button. The indoor unit operation indicator lamp (red) will light. The air conditioner will begin to operate.
- (2) Press the MASTER CONTROL button to select the desired mode. Each time the button is pressed, the mode will change in the following order.

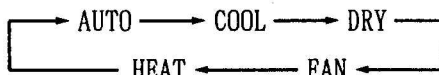

About three seconds later, the entire display will reappear.

⑧ SET TEMP./SET TIME BUTTONS

- (1) Press the SET TEMP. buttons.

⊕ button:
Press to raise the thermostat setting.
⊖ button:
Press to lower the thermostat setting.

- (2) Thermostat setting range:
 AUTO •• Standard temperature setting $\pm 2^{\circ}\text{C}$
 Heating 16 ~ 30 $^{\circ}\text{C}$
 Cooling/Dry.... 18 ~ 30 $^{\circ}\text{C}$
 Fan 17 ~ 30 $^{\circ}\text{C}$
 (During use of Fan mode, if the thermostat is set at 17 $^{\circ}\text{C}$ or lower, the display will show "--" and the fan will operate continuously, regardless of the room temperature.)

The thermostat cannot be used to set the room temperature during the FAN mode (the temperature will not appear on the remote control unit display).

NOTE: The thermostat setting should be considered a standard value, and may differ somewhat from the actual room temperature.

⑨ FAN CONTROL BUTTON

- (1) Press the FAN CONTROL button. Each time the button is pressed, the fan speed changes in the following order:

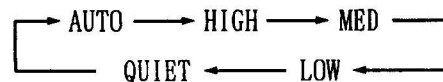

About three seconds later, the entire display will reappear.

When set to AUTO:

Heating: Fan operates so as to be optimally warmed air. However, the fan will operate at very low speed when the temperature of the air issued from the indoor unit is low.

Cooling: As the room temperature approaches that of the thermostat setting, the fan speed becomes slower.

Fan : The fan alternately turns on and off; when on, the fan runs at a low fan speed.

The fan will operate at very low setting during Monitor operation and at the start of the Heating mode.

⑩ TIMER BUTTON

A) To use the ON timer or OFF timer

- (1) Press the START/STOP button (if the unit is already operating, proceed to step 2). The indoor unit operation indicator lamp (red) will light.
- (2) Press the TIMER button to select the ON timer or OFF timer operation. Each time the button is pressed the timer function changes in the following order:

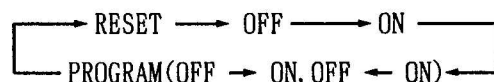

The indoor unit TIMER indicator lamp (green) will light.

- (3) Use the SET TIME button to adjust the desired OFF time or ON time. Set the time while the time display is flashing (the flashing will continue for about five seconds).

⊕ button: Press to advance the time.

⊖ button: Press to reverse the time.

About five seconds later, the entire display will reappear.

B) To Use the Program timer

- (1) Press the START/STOP button (if the unit is already operating, proceed to step 2). The indoor unit operation indicator lamp (red) will light.

- (2) Set the desired times for OFF timer and ON timer.

See the section "To Use the ON timer or OFF timer" to set the desired mode and times. About three seconds later, the entire display will reappear. The indoor unit timer indicator lamp (green) will light.

- (3) Press the timer button to select the PROGRAM timer operation (either OFF → ON or OFF ← ON will display).

The display will alternately show "Off timer" and "ON timer", then change to show the time setting for the operation to occur first. The PROGRAM timer will begin operation. (if the ON timer has been selected to operate first, the unit will stop operating at this point). About five seconds later, the entire display will reappear.

⑪ SLEEP BUTTON

To Use the SLEEP timer

- (1) While the air conditioner is operating or stopped, press the SLEEP button. The indoor unit operation indicator lamp (red) lights and the timer indicator lamp (green) lights.

To Change the Timer Settings

Press the SLEEP button once again and set the time using the SET TIME button. Set the time while the Timer Mode Display is flashing (the flashing will continue about five seconds).

⊕ button: Press to advance the time.

⊖ button: Press to reverse the time.

About five seconds later, the entire display will reappear.

⑫ AIRFLOW DIRECTION BUTTON

Vertical Air Direction Adjustment:
Press the AIRFLOW DIRECTION button.

Each time the button is pressed, the air direction range will change as follows:

- ① ↔ ② ↔ ③ ↔ ④ ↔ ⑤ ↔ ⑥ ↔ ⑦

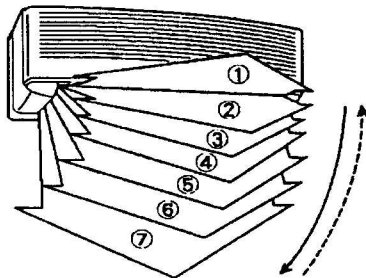

Type of Airflow Direction Setting:

①, ②, ③, ④ : During Cooling/Dry modes

①, ②, ③, ④, ⑤, ⑥, ⑦ : During Fan mode

⑤, ⑥, ⑦ : During Heating mode

The remote control unit display does not change.

Use the air direction adjustment within the ranges shown above.

The vertical airflow direction is set automatically as shown, in accordance with the type of operation selected.

[COOLING MODEL]

During Cooling/Dry mode: Horizontal flow ①
During Fan mode : Downward flow ⑦

[REVERSE CYCLE MODEL]

During Cooling/Dry mode: Horizontal flow ①
During Fan mode : Horizontal flow ①
During Heating mode : Downward flow ⑦

During AUTO mode operation, for the first minute after beginning operation, airflow will be horizontal ①; the air direction cannot be adjusted during this period.

Right-Left Adjustment

Adjust the Right-Left louvers.
Move the Right-Left louvers to adjust air flow in the direction you prefer.

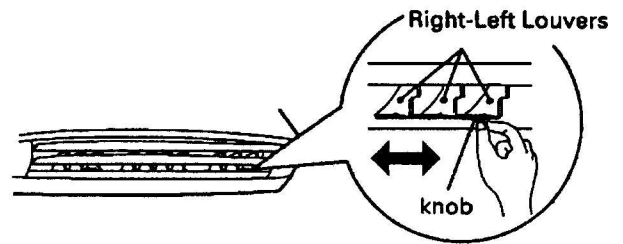

⑬ SWING OPERATION

- To select swing operation
<Press the swing louver button.>
The swing indicator lamp (orange) will light.

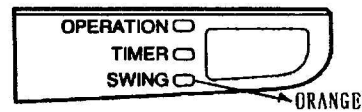

In this mode, the air flow direction louvers will swing automatically to direct the airflow both up and down.

- To stop swing operation
<Press the swing louver button once again.>
The swing indicator lamp will go out. Airflow direction will return to the setting before swing was begun.
About swing operation
 - * The range of swing is relative to the currently set airflow direction.
 - * If the swing range is not as desired, use the remote control units air flow direction button to change the range of swing.
 - * During Cooling/Dry modes, if swing operation is continued at the lowest (downward) range for more than 30 minutes, the unit will automatically switch the swing range to the horizontal flow range, to prevent the condensation of moisture on the outlet.
 - * The swing operation may stop temporarily when the air conditioner's fan is not operating at very low speed.

10. TIMER

There are four timer modes: "SLEEP", "OFF TIMER", "ON TIMER" and "PROGRAM TIMER".

- (1) Set the clock time when the unit is in the stop mode (only the current time will be shown on the remote control unit display).
- (2) While adjusting the current clock time, do not use other remote control functions.
- (3) Each time the TIMER button is pressed, the remote control unit display will change in order as shown below :

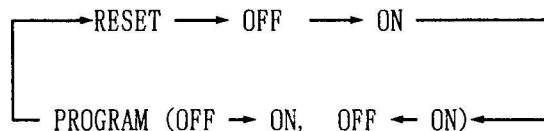
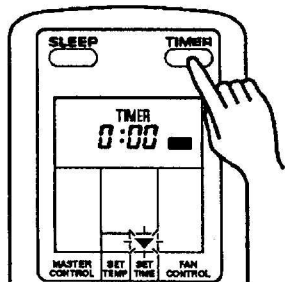

① SLEEP timer

When desiring to stop operation automatically after you go to bed, if the SLEEP button is pressed, operation stops while the "room temperature" is changed automatically.

*Cooling/Drying

When set to the "SLEEP", the set temperature is raised 1.0°C, then raised 1.0°C/1 hour thereafter. When the temperature has been raised a total of 2°C, that temperature is held until the set time has elapsed, then operation automatically stops.

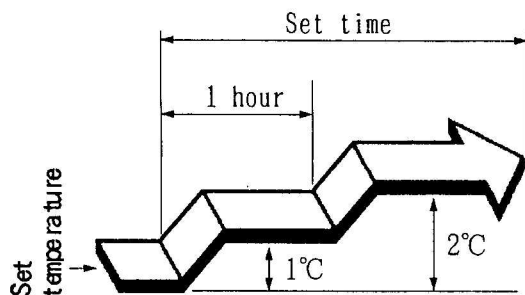

*Heating [REVERSE CYCLE]

When set to the "SLEEP", the set temperature is lowered 1°C, then lowered 1°C/30 minutes thereafter. When the temperature has been lowered at a total of 4°C, that temperature is held until the set time has elapsed, then operation automatically stops.

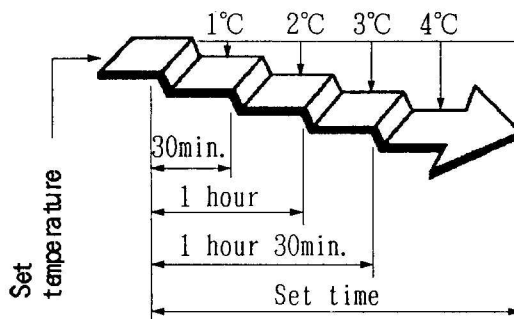

② OFF TIMER

Use when going to bed or otherwise to stop operation. When the clock reaches the set time, the air conditioner will be turned off.

③ ON TIMER

For wake up operation or otherwise to start operation. Depending on the difference between the actual room temperature and the set temperature value, the unit will start operation automatically in order to bring the room temperature to the desired set temperature value by the time previously set.

The higher or lower the room temperature is (relative to the set temperature), the earlier the unit will start its operation. ON-timer operation will start:
 For heating : 45 ~ 10 minutes before the set time
 For cooling : 20 ~ 10 minutes before the set time

In the case of FAN mode, the operation will start precisely at the set time.

④ PROGRAM TIMER

The PROGRAM timer allows you to integrate OFF timer and ON timer operations in a single sequence. The sequence can involve one transition from OFF timer to ON timer, or from ON timer to OFF timer, within a twenty four hour period.

The first timer function to operate will be the one set nearest to the current time. The order of operation is indicated by the arrow in the Remote Control Unit display (OFF → ON, or OFF ← ON).

One example of PROGRAM timer use might be to have the air conditioner automatically stop (OFF timer) after you go to sleep, then start (ON timer) automatically in the morning before you arise.

11. FAN CONTROL

A) "AUTO" POSITION

1) COOLING OPERATION

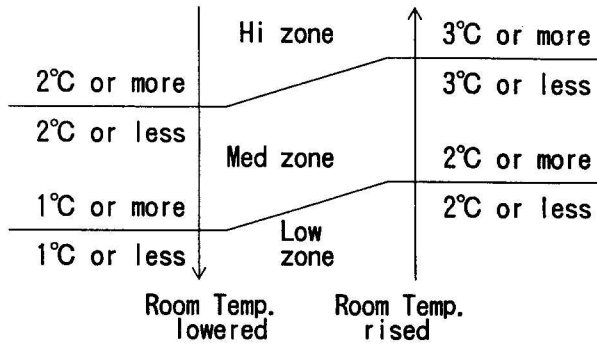

Air flow mode is set automatically in accordance with the condition "(Room temp. - Set temp.)" as shown in the left.

2) HEATING OPERATION

- (1) When the indoor heat exchanger temperature becomes 47 °C or more, the fan mode switches to higher position for one step ("LOW" → "MED", "MED" → "HIGH").
- (2) When the indoor heat exchanger temperature lowers less than 41 °C while the compressor operates, the fan mode switches to lower position for one step. ("HIGH" → "MED", "MED" → "LOW")
- (3) After switching the fan mode, it does not switch within 2 minutes.
- (4) When "FAN CONTROL" is switched to "AUTO" while the unit is operated at the "FAN CONTROL" position of "HIGH", "MED" or "LOW", the unit operates in the "MED" fan mode at the room temperature of more than 41°C and in the "Low" fan mode at the room temperature of less than 41°C.

B) "LOW", "MED" and "HIGH" position

The indoor fan operates at an air flow set in FAN CONTROL mode.

C) QUIET position

Quiet operation begins. The indoor unit airflow will be reduced for quieter operation. Quiet operation cannot be used during Dry mode. (In the same way, when the dry mode is selected during AUTO mode operation, SUPER QUIET operation cannot be used.) During Super Quiet operation, heating and cooling performance will be reduced somewhat.

12. OPERATING MODE

(1) "AUTO" position:

Depending on the room temperature when operation begins, the operating mode will be switched automatically as shown in the accompanying table. Also, depending on the operating mode, the room temperature setting will cause the "standard" temperature to be set as shown.

Mode	Standard temperature			Thermostat temperature setting range
	Room Temperature	Operating Mode	Temperature Setting (standard)	
Auto	30°C or more	⇒ Cool	⇒ 27°C	Standard temperature setting ± 2°C
	27°C to 30°C	⇒ Cool	⇒ 26°C	
	24°C to 27°C	⇒ Dry	⇒ 24°C	
	22°C to 24°C	⇒ Monitor		
	Less than 22°C	⇒ Heat	⇒ 23°C	
Heating	—————			16 ~ 30°C
Cooling/Dry	—————			18 ~ 30°C

① Once the operating mode has been set, the mode will not change even if the room temperature changes. However, during the monitor operation mode, if the room temperature changes to below 22°C, the mode will automatically switch to heating, and when it rises above 24°C the mode will automatically switch to drying.

② In the monitor mode, the fan will operate very slowly (S-Low mode).

- ③ In the dry mode, the fan will operate slowly to prevent room humidity from increasing, and the room fan may stop.
- ④ During defrosting operation in the heating mode, the OPERATION indicator lamp will flash slowly and the heating mode will stop temporarily.

(2) "FAN" position:

- ① In this position, the fan operates alone to circulate air. The room temperature will not be changed.
- ② Operates at an air flow set in the FAN CONTROL mode.

(3) "DRY" position:

- ① In the dry mode, since preference will be given to remove humidity, the room temperature may not be lowered to the selected value.
- ② When using the dry mode, set the temperature to a value lower than the actual current room temperature. If it is set higher than the current room temperature, the unit will not enter the dry mode.
- ③ Room heating cannot be performed in the dry mode.
- ④ In the dry mode, the optimum fan speed will be set automatically and cannot be changed. The fan will emit a very weak stream of air.
- ⑤ In the dry mode, the room fan may occasionally stop in order to prevent room humidity from increasing.

(4) "COOL" position:

When using the cooling mode, set the temperature to a value lower than the actual current room temperature. If it is set higher than the current room temperature, the unit will not enter the cooling mode and only the fan will operate.

(5) "HEAT" position: [REVERSE CYCLE]

- ① Set the temperature higher than the actual current room temperature. If it is set to a lower temperature value, heating does not start.
- ② For about 3 to 5 minutes after starting heating, the fan will operate very slowly, then switch to the selected fan setting. This period is to allow the indoor unit heat exchanger to prewarm before emitting warm air.
- ③ During defrosting, the OPERATION indicator lamp will flash slowly, and the heating mode is temporarily interrupted.

13. AUTO RESTART

The air conditioner power has been interrupted by a power failure. The air conditioner will then restart automatically in its previous mode when the power is restored.

Operated by setting before the power failure. Then, the air flow direction louvers will automatically change to their standard direction.

If a power failure occurs during TIMER operation, the timer will be reset and the unit will begin (or stop) to operate at the new time setting. In the event that this kind of the timer fault occurs the TIMER indicator lamp (green) will flash.

Use of other electrical appliances (electric shaver, etc.) or nearby use of a wireless radio transmitter may cause the air conditioner to malfunction. In this event, temporarily disconnect the power supply plug, reconnect it, and then use the power control unit to resume operation.

14. PROTECTING THE INDOOR FAN MOTOR BY LOCKING

When the indoor fan motor starts or the fan control mode is changed, the indoor fan motor detects number of revolutions in 56 seconds. When the indoor fan motor shows the unusual revolutions, it then stops.

Indication lamp : See CHECK 9 for LED abnormal indications.

DEFROSTING OPERATION FLOW CHART (REVERSE CYCLE) DEFROSTING (Only at "Heating" flow chart)

— Meaning of symbols —

O.L.P. (Overload Protector) is operating : If the indoor heat exchanger temperature is too high, the outdoor fan is stopped to prevent the former from rising.

T_c : Indoor heat exchanger temperature (Indoor pipe thermistor detector)
 T_R : Room temperature (Room thermistor detector)

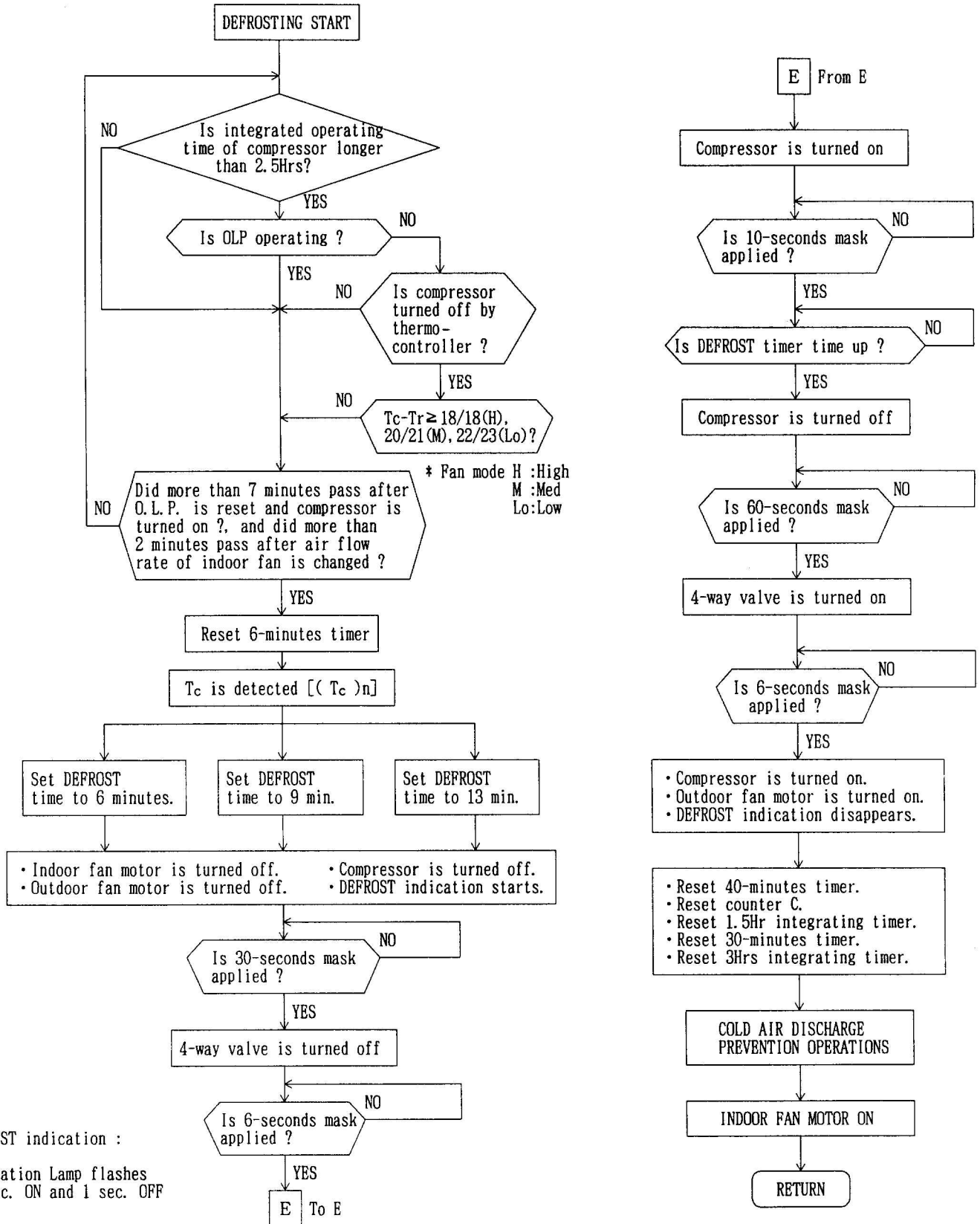

DEFROST indication :
 Operation Lamp flashes
 3 sec. ON and 1 sec. OFF

TROUBLESHOOTING

1. WORKING INSPECTION (When cooling)

Symptom	Possible causes	Remedy
(1)Indoor unit evaporator is covered with frost. a. Frost near inlet. b. Frost all over.	Gas leakage Clogged filter Low ambient temperature (less than 20°C)	Check the leaked part, and charge gas. Clean the filter. Check the ambient temperature
(2)Compressor operates, but it does not cool.	Stained condenser	Clean.
(3)Water does not come out of the drain hose.	When the compressor operates normally, the gas leaks.	Charge gas and replace the parts.
(4)Return pipe(low pressure) of the compressor is not cold.	Gas leakage	Charge gas. Replace the parts.
(5)Outlet pipe(high pressure) of the compressor is not hot.	Gas leakage	Charge gas.
(6)Compressor operates, but does not cool. a. Indoor unit evaporator is cold. b. Outdoor unit condenser is hot, but it does not cool.	Overload operation Stained condenser	Eliminate overload. Clean.
(7)Indoor unit air outlet temperature is low, but it does not cool.	Clogged filter The cooled air is short-circuited. Overload operation	Clean. Isolate the problem and correct. Eliminate the overload.

2. SYMPTOMS AND CHECK ITEMS

Symptom	Possible causes	Check item	Check points
No operation.	Power supply circuit faulty Microcomputer reset circuit faulty Remote control faulty External wiring receiving section faulty	Check 1 Check 2	Power supply circuit Microcomputer input signal Remote control troubleshooting
Erroneous operation. (runaway)	Microcomputer runaway	Check 3	Reset circuit
Display does not light correctly.	Display unit faulty LED driver faulty	Check 4	Display unit Microcomputer output signal Driver output signal
Room temperature cannot be controlled.	Room thermistor faulty Pipe temperature thermistor faulty A/D converter input section faulty Compressor relay circuit faulty	Check 5 Check 8 Check 6	Thermistor resistance value Microcomputer input signal Relay output
Room fan does not run and wind speed cannot be switched.	Wind speed relay faulty	Check 7	Microcomputer output signal Driver output signal
Indication panel abnormal.	Thermistor short-circuited or opened	Check 9	Thermistor resistance value

(4) Protecting the indoor fan motor by locking
 When the indoor fan will not run and the lamp is flashing on and off as shown in the Fig.1, the indoor fan motor protection by locking is functioning.
 This function is released once by disconnecting the power plug.

Fig.1

* protecting the indoor fan motor by locking.

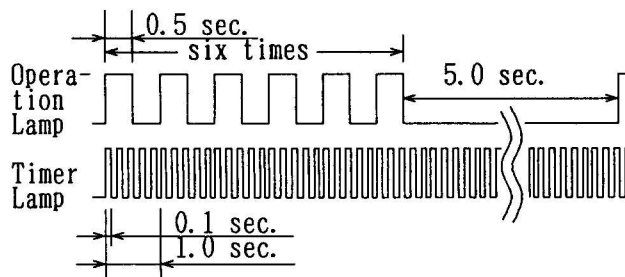

CHECK 8

- Room temperature thermistor
 * CN2 disconnected. CN2 No.1-2 short-circuited.
 * Thermistor faulty
 * R37 open, short-circuited.
 C18, C20 short-circuited
 R22, R33 open.
 * See CHECK 9 for LED abnormal indications.

Heat exchanger (Pipe) thermistor

- * CN3 disconnected. CN3 No.1-2 short-circuited.
 * Thermistor faulty
 * R38 open, short-circuited.
 C19, C21 short-circuited.
 R35, R36 open.
 * See CHECK 9 for LED abnormal indications.

CHECK 9

Thermistor Abnormal Indication

- (1) Whether during operation or non-operation, when the room temperature thermistor or heat exchanger thermistor is opened or short-circuited, operation is immediately stopped and failure indication (see item (3) described below) is displayed.
- (2) In the case that this function stops the operation, any operation instruction cannot resume the operation.
- (3) Failure indications stated in (1) are shown in the Fig.2.

Fig.2

* Room temperature thermistor and heat exchange (pipe) thermistor are abnormal.

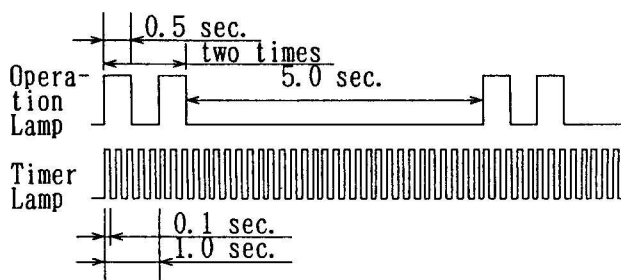

3. Thermistor resistance values

1) Room temperature thermistor

Room temperature(°C)	3	5	8	10	15	20	25	29	31	33	36	40	44
Resistance value(kΩ)	28.7	25.9	22.3	20.1	15.8	12.5	10.0	8.4	7.7	7.0	6.2	5.3	4.5

2) Heat exchanger (pipe) temperature thermistor

Pipe temperature(°C)	0	2	6	10	14	18	22	26
Resistance value(kΩ)	176.0	157.8	127.3	103.3	84.4	69.3	57.2	47.5
Pipe temperature(°C)	30	34	38	44	50	56	60	
Resistance value(kΩ)	39.6	33.2	27.9	21.7	17.0	13.5	11.6	

PRECAUTIONS ON INSTALLATION

1. DRAIN PIPE INSTALLATION [REVERSE CYCLE]

Since the drain water flows from the outdoor unit during heating operation when it is installed at a high place, install the drain pipe as shown in Fig. 1 and connect it to a 16mm (inside diameter) hose available at stores. (Fig. 2)

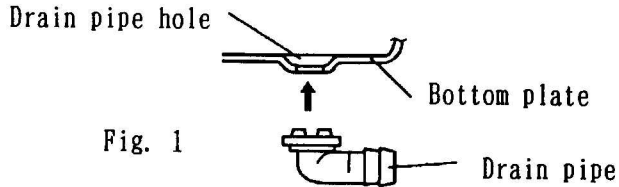

Fig. 1

• 9000, 12000 BTU/h MODELS

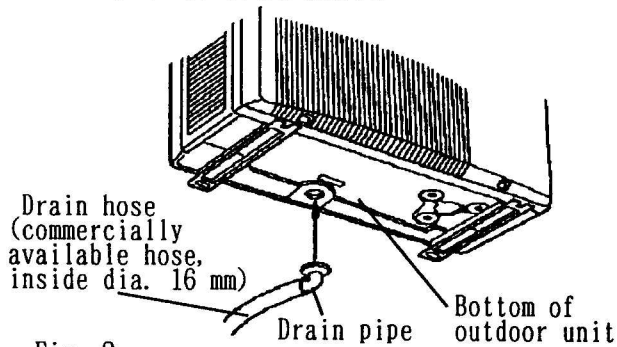

Fig. 2

2. AIR PURGE

- 1) Purge the air inside the indoor unit and the piping to a pressure of 1.5 mmHg abs or less from the charging valve with a vacuum pump.
- 2) After purging the air inside the indoor unit and the piping, remove the cap of the two valves.
- 3) Open the spindle of the two valves from the closed state.
- 4) Tighten the cap of the two valves to the specified torque.

	Tightening torque kgf-cm	
	2-way valve	3-way valve
Spindle	70 ~ 90	
Cap(1/4", 3/8")	200~250	
Cap(1/2")	280~320	

- 5) Tightening torque of flare nut.

Flare nut tightening torque	
1/4" (6.35mm)	160 ~ 180 kgf-cm
3/8" (9.52mm)	300 ~ 420 kgf-cm
1/2" (12.70mm)	500 ~ 550 kgf-cm

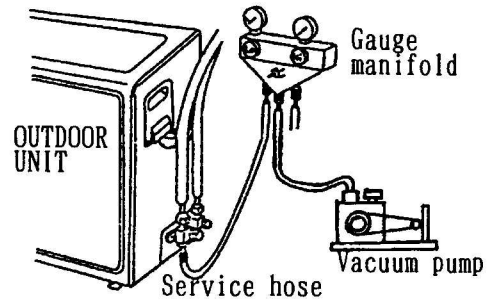

3. PUMP DOWN

(Draining the refrigerant to the outdoor unit)

When the connection pipe must be disconnected or the unit is moved to another place, the refrigerant in the indoor unit and pipes should be drained into the outdoor unit. This procedure is called "Pump down".

- 1) Fully close the valve spindle of the two-way valve. (Turn clockwise.)
- 2) Connect the charging valve of the three-way valve to the low pressure gauge manifold with a charge hose.
- 3) Set the three-way valve to its middle position, slightly open the low pressure valve of the gauge manifold to discharge the air from the charge hose and close the valve
- 4) While running the air conditioner, close the three-way valve (turn the valve spindle clockwise) when the low pressure gauge reads 0.5kg/cm², and stop the air conditioner.
- 5) After disconnecting the pipes, attach the screw caps and tighten securely the flare nut.

Low pressure gauge indication: 0.5kg/cm²

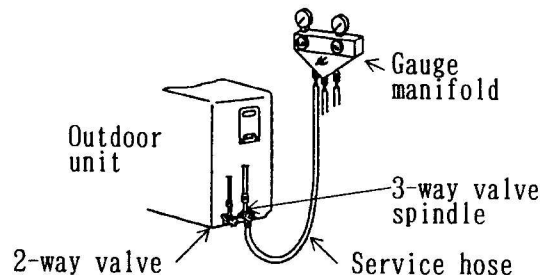

4. COLLECTING AND CHARGING REFRIGERANT

- 1) Collecting
When the pipe must be unbrazed to repair the refrigeration cycle, carefully collect the refrigerant as follows.

Note: Since there is in danger of frostbite if you touch the refrigerant directly, perform this work carefully.

- (1) Remove the cap, and connect the refrigerant collecting device to the charging valve.
- (2) Collect the refrigerant in the unit into the collecting device or a special tank.
(The collected refrigerant cannot be used unless it is refined.)

【CAUTION】

When collecting the refrigerant, observe the environment protection regulations and laws in each district.

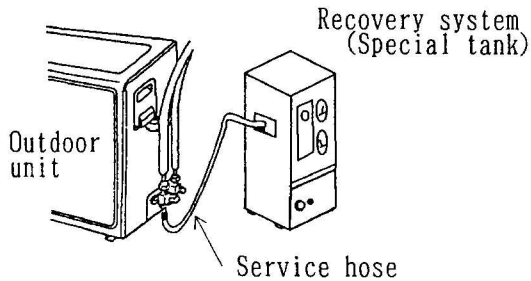

- 2) Charging.
To charge the refrigerant, proceed as described below.
 - (1) Check that the refrigeration cycle is connected perfectly.
 - (2) Evacuate the cycle to a vacuum from the charging valves connection to the outdoor unit.
 - (3) After evacuation, charge the refrigerant from the large pipe charging valve.

• Additional refrigerant charge :
Refrigerant suitable for a piping length of 5m is charged in the outdoor unit at the factory. When the piping is 5m or more long, it is necessary to additional refrigerant. For the additional amount, see the table below.

9000, 12000 BTU/H MODELS

Pipe length	16 ft (5 m)	23 ft (7 m)	33 ft (10 m)
Additional refrigerant	None	1.1 oz (32 g)	2.8 oz (80 g)

Between 5m and 10m, when using a connection pipe other than that in the table, charge additional refrigerant with 0.56 oz. (16g)/ 3.3 ft(1 m) as the criteria.

【CAUTION】

- * Always pump down the piping before use.
- * When charging the refrigerant, always use a measuring cylinder.
- * Add refrigerant from the charging valve after completion of the work.
- * Do not operate the compressor at the first of the charging.
- * However, the compressor can be operated if no more refrigerant will enter the cycle.

5. HEIGHT DIFFERENCE

Limit the height difference between the indoor unit and outdoor unit as stated below.
: Within 5 m (16 ft)

If the units are further apart than this, correct operation cannot be guaranteed.

6. ALLOWABLE LENGTH OF CONNECTING PIPE

The maximum length of the piping are as follows.

9000, 12000 BTU/H MODELS
: Within 10 m (33 ft)

If the units are further apart than this, correct operation cannot be guaranteed.

7. AREA LIMIT ON USE BY HEATING OPERATION (REVERSE CYCLE)

*These models are designed not to use in the area where the temperature in winter is less than 0 °C

*Do not perform "Heating" operation when the outdoor temperature is below 0°C otherwise the compressor may be damaged due to the defrosting performance drop.

*Heating capacity also lowers extremely when the outdoor temperature is below 0°C. Relation between outdoor temperature and heating capacity is shown in the following figure. (Mean value)

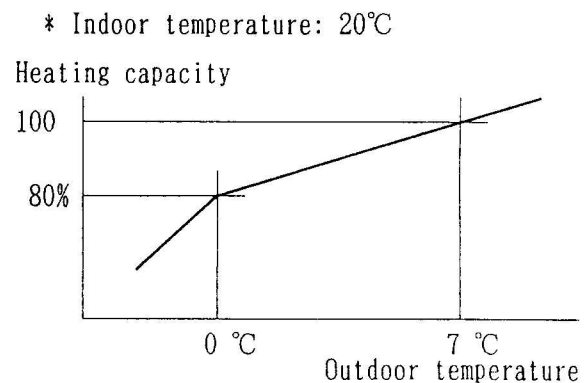

8. TEMPERATURE INDICATION

The temperature set on the remote controller may differ from the temperature at the installation place, distribution of the room temperature and sun-light approaching condition etc..

9. WIRING CONNECTION BETWEEN THE INDOOR UNIT AND OUTDOOR UNIT

* Match the terminal block numbers and connection cord colors with those of the indoor unit.

* Erroneous wiring may cause burning of the electric parts.

* Always fasten the outside covering of the connection cord with cable clamps.
(If the insulator is clamped, electric leakage may occur.)

— Wiring connection

(1) COOLING MODEL type

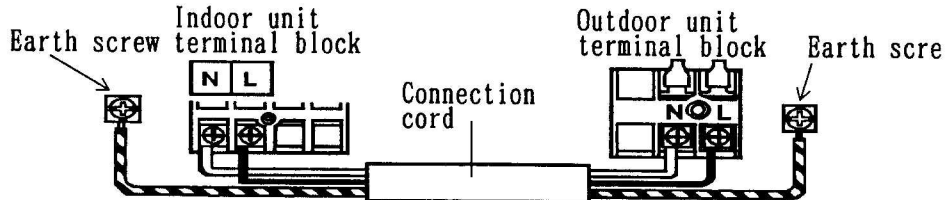

(2) REVERSE CYCLE MODEL type

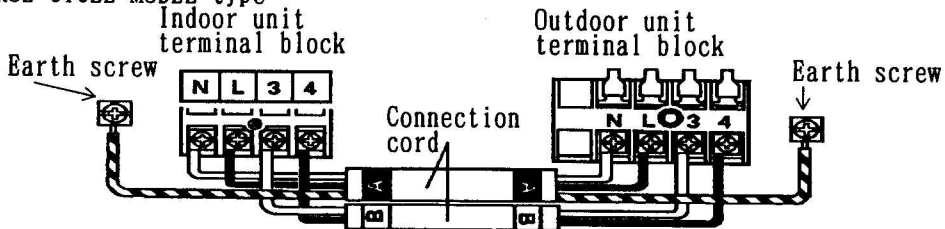

10. ELECTRICAL WORK (POWER SUPPLY)

As shown in the figure, an exclusive power supply circuit should be provided without fail.

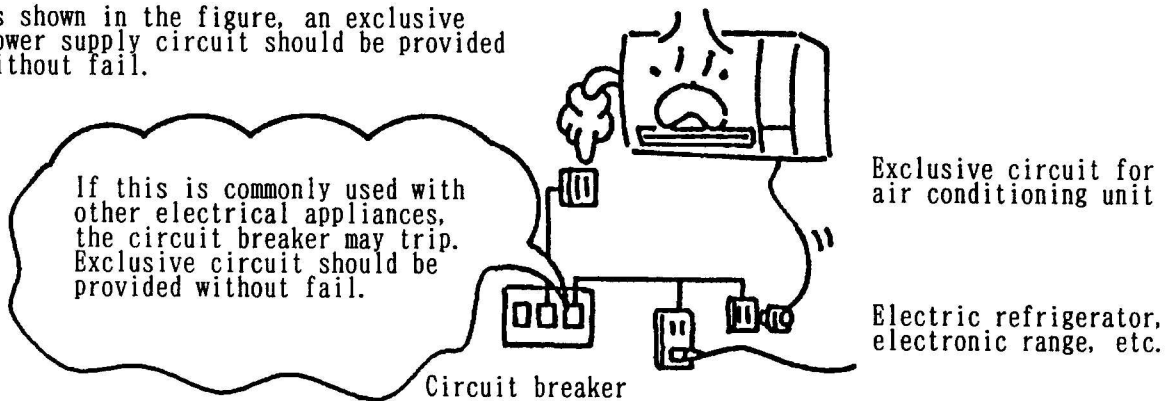

11. POWER CORD REPLACEMENT [EUROPEAN MODEL]

The special screw driver is needed to remove the earth screw as shown below.

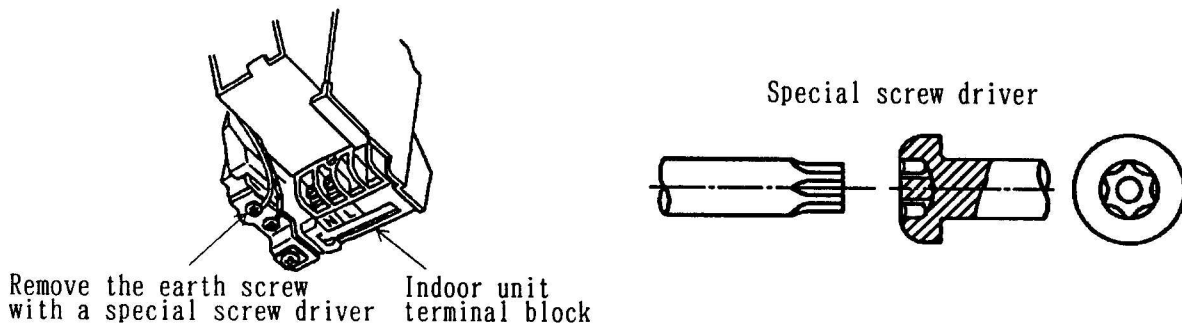

Remove the earth screw with a special screw driver Indoor unit terminal block

12. PIPING

1) Flaring of Pipe

The following figure shows the optimal pipe position to make flare.

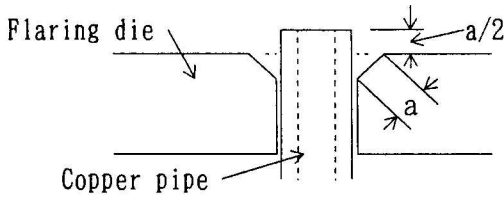

Flare part shall be as shown below.

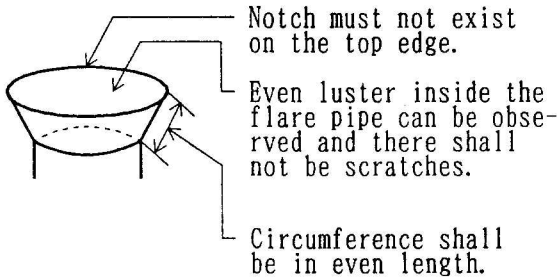

* Poor Flaring

The figures shown below bring gas leakage.

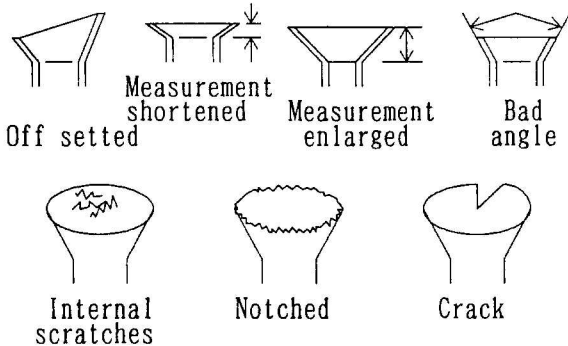

2) Flare Nut Tightening

① As shown in Fig. 1, adjust the pipe so that the center line of the pipe sets to that of the valve, and then tighten the flare nut by hands. (Tightening the nut with a spanner initially causes the thread to damage and gas leakage.)

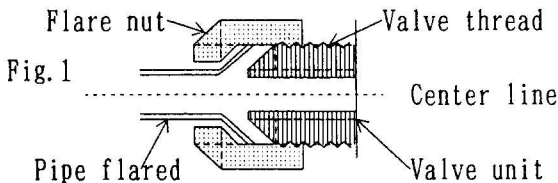

② To tighten the flare nut, use a torque wrench.

③ The flare part is extended and gas leakage may occur, if excessive force is applied to tighten the flare nut as shown in Fig. 2.

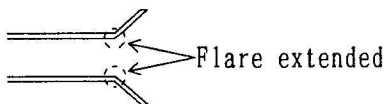

Fig. 2

④ Tightening the flare nut on the indoor unit side should be done with 2 spanners as shown in Fig. 3.

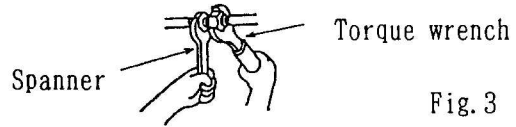

Fig. 3

3) When installing, take care of the following points.

A. Drying:

Never allow water and air to enter the unit.

- (1) Do not install piping on a rainy day.
- (2) To store copper pipe, cap the pipe.
- (3) Always perform air purge.



B. Cleaning:

Never allow dust or dirt to enter the unit.

- (1) When removing burrs from the flare nuts, point the pipe opening downward.
- (2) When passing the copper pipe through a through-hole, cover the opening with a cap or vinyl tape.

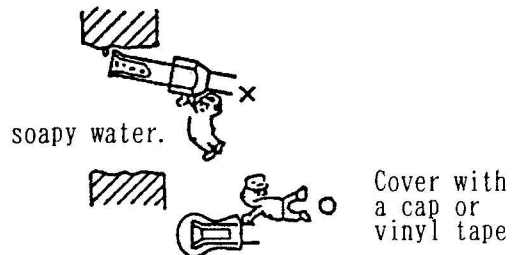

C. Air tightness:

The coolant refrigerant should not leak.

- (1) Connect the flare pipe so that it is tight.
- (2) Use 2 spanners to tighten the flare nuts.
- (3) Securely cover with caps.
- (4) Carefully check for air-tightness with soapy water.

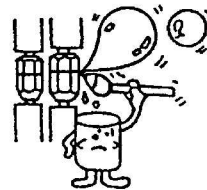

AIR CLEANING FILTER FOR ROOM AIR CONDITIONER

MODEL APS-03B
APS-02F

INSTRUCTION MANUAL

1. FEATURES

The air cleaning filter cleans the room by electrostatically removing cigarette smoke and invisible dust from the air.

2. AIR CLEANING FILTER INSTALLATION

Use the air cleaning filter by installing it at the back of the two air filters of the indoor unit as described below.

(1) Open the intake grille and remove the air filter.

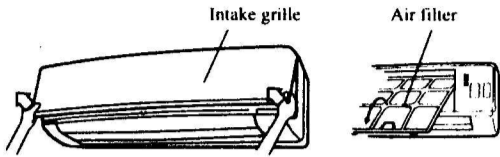

(2) Install the two air cleaning filters.

① Insert the air cleaning filter into the air cleaning filter frame.

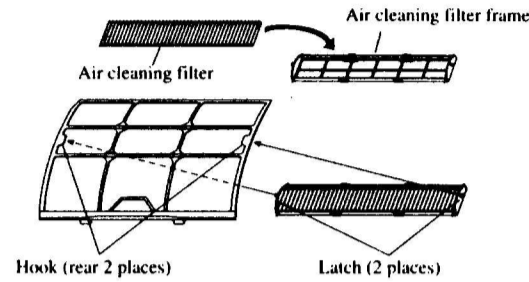

② Hook the latches at both ends of the air cleaning filter frame to the two hooks on the rear of the air filter.

Be sure that the air cleaning filter does not protrude from the frame.

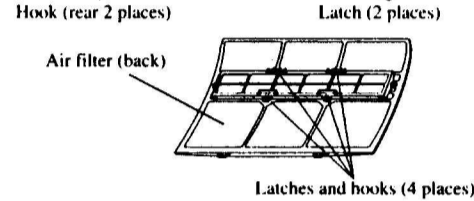

③ Turn over the air filter and push the four latches of the air cleaning filter frame from the top and hook them to the air filter hooks.



(3) Install the two air filters to the air conditioner and close the intake grille.

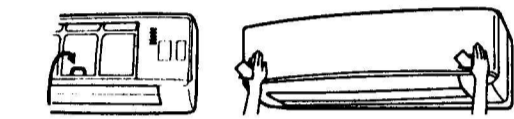

3. REPLACING THE AIR CLEANING FILTER

(1) Open the intake grille and remove the air filter.

(2) Replace the air cleaning filter.

① Pull the air cleaning filter frame off of the air filter and remove the dirty air cleaning filter.

② Install the new replacement air cleaning filter according to [2. AIR CLEANING FILTER INSTALLATION].

(3) Install the two air filters to the air conditioner and close the intake grille.

4. STICKING THE COLOR SEAL

Stick the color seal at the position shown at the right and use it as an air cleaning filter replacement criteria.

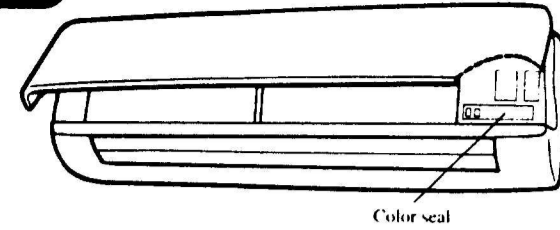

Color seal

5. HANDLING PRECAUTIONS

- Do not wash the air cleaning filter. The air cleaning effect will be lost.
- Do not place the air cleaning filter near a stove or other heating equipment. It will be deformed and its air cleaning effect will be lost.
- When using the air cleaning filter, a greater effect will be obtained if air flow is set to HIGH.
- When the air cleaning filter is used, the air flow will decrease and the air conditioner capacity will drop somewhat.
- Do not store the air cleaning filter where it is hot or humid. Use the filter soon after unsealing it. (If the filter is left unsealed, the air cleaning effect will drop.)

6. AIR CLEANING FILTER REPLACEMENT CRITERIA

- The life of the air cleaning filter depends on how the air conditioner is used, but is approximately three months. If the color of the air cleaning filter approaches that of the color seal stuck to the indoor unit even before three months has elapsed, replace the filter as soon as possible. (The air cleaning filter cannot be reused.)



Color seal

- Purchase a replacement air cleaning filter set (APS-02F) from your air conditioner dealer.

7. PARTS DETAILS

Part name	Shape	Q'ty
* Air cleaning filter frame		2
Air cleaning filter		2
* Color seal		1

* Not included with air cleaning filter set (APS-02F).