

**OPERATING MANUAL  
BEDIENUNGSANLEITUNG  
MODE D'EMPLOI  
MANUAL DE FUNCIONAMIENTO  
MANUALE DI ISTRUZIONI  
ΕΓΧΕΙΡΙΔΙΟ ΛΕΙΤΟΥΡΓΙΑΣ  
MANUAL DE INSTRUÇÕES**

**HEAT & COOL MODEL  
(REVERSE CYCLE)  
ROOM AIR CONDITIONER  
WALL MOUNTED TYPE**

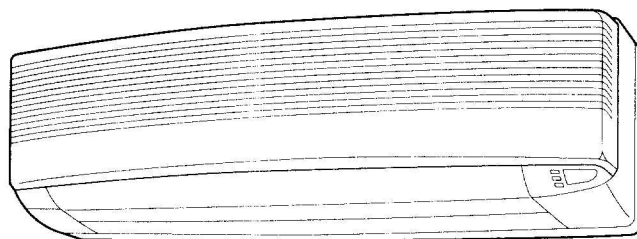

Indoor Unit  
**ASY9RSGCW  
ASY12RSGCW**  
Outdoor Unit  
**AOY9RSGC  
AOY12RSGC**



English

Deutsch

Français

Español

Italiano

Ελληνικά

Português

KEEP THIS OPERATION MANUAL  
FOR FUTURE REFERENCE

FUJITSU GENERAL LIMITED

P/N9308139016-01

# CONTENTS

SAFETY PRECAUTIONS .....	En-1	ADJUSTING THE DIRECTION OF	
FEATURES AND FUNCTIONS .....	En-2	AIR CIRCULATION .....	En-9
NAME OF PARTS .....	En-3	SWING OPERATION .....	En-10
PREPARATION .....	En-4	MANUAL AUTO OPERATION .....	En-10
OPERATION .....	En-5	CLEANING AND CARE .....	En-11
TIMER OPERATION .....	En-7	TROUBLESHOOTING .....	En-12
SLEEP TIMER OPERATION .....	En-8	OPERATING TIPS .....	En-13

## SAFETY PRECAUTIONS



### DANGER!

- Do not attempt to install this air conditioner by yourself.
- This unit contains no user-serviceable parts. Always consult authorized service personnel for repairs.
- When moving, consult authorized service personnel for disconnection and installation of the unit.
- Do not become excessively chilled by staying for lengthy periods in the direct cooling airflow.
- Do not insert fingers or objects into the outlet port or intake grilles.
- Do not start and stop air conditioner operation by disconnecting the power supply cord and so on.
- Take care not to damage the power supply cord.
- In the event of a malfunction (burning smell, etc.), immediately stop operation, disconnect the power supply plug, and consult authorized service personnel.
- If the power supply cord of this appliance is damaged, it should only be replaced by the authorized service personal, since special purpose tools and specified cord are required.



### CAUTION!

- Provide occasional ventilation during use.
- Do not direct air flow at fireplaces or heating apparatus.
- Do not climb on, or place objects on, the air conditioner.
- Do not hang objects from the indoor unit.
- Do not set flower vases or water containers on top of air conditioners.
- Do not expose the air conditioner directly to water.
- Do not operate the air conditioner with wet hands.
- Do not pull power supply cord.
- Turn off power source when not using the unit for extended periods.
- Check the condition of the installation stand for damage.
- Do not place animals or plants in the direct path of the air flow.
- Do not drink the water drained from the air conditioner.
- Do not use in applications involving the storage of foods, plants or animals, precision equipment, or art works.
- Connection valves become hot during Heating; handle with care.
- Do not apply any heavy pressure to radiator fins.
- Operate only with air filters installed.
- Do not block or cover the intake grille and outlet port.
- Ensure that any electronic equipment is at least one metre away from either the indoor or outdoor units.
- Avoid installing the air conditioner near a fireplace or other heating apparatus.
- When installing the indoor and outdoor unit, take precautions to prevent access to infants.
- Do not use inflammable gases near the air conditioner.

Fig. 1

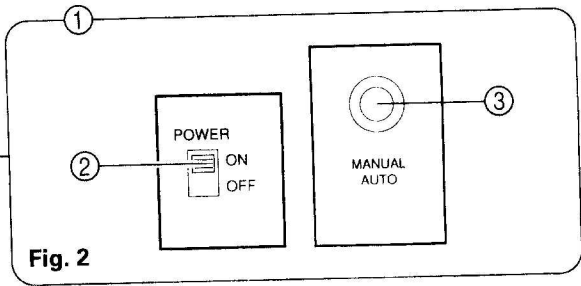
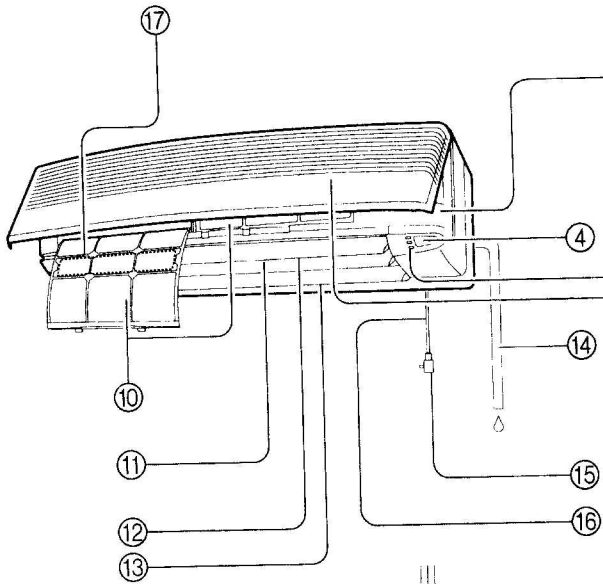

Fig. 2

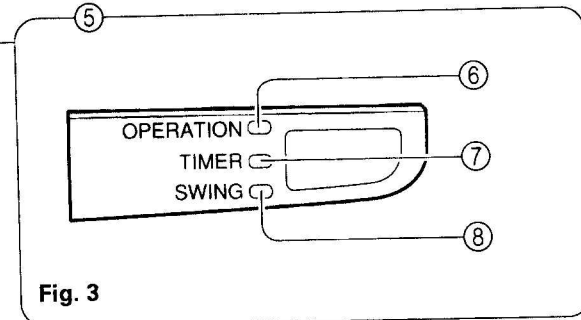

Fig. 3

Fig. 5

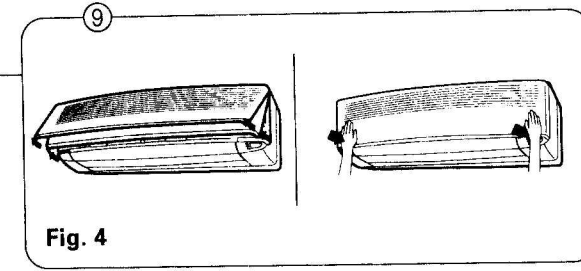
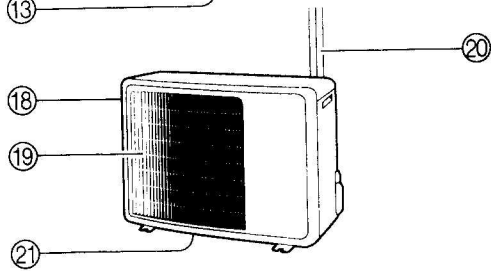

Fig. 4

Fig. 6

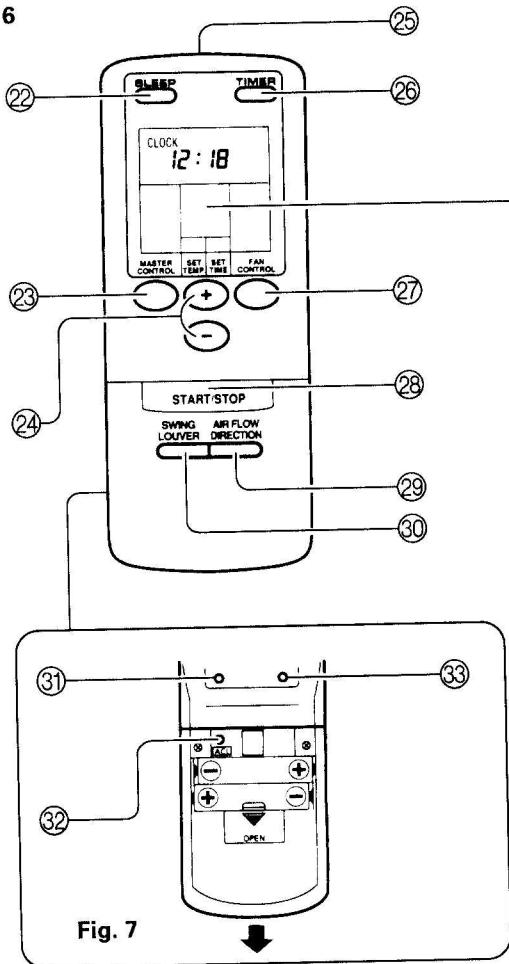

Fig. 7

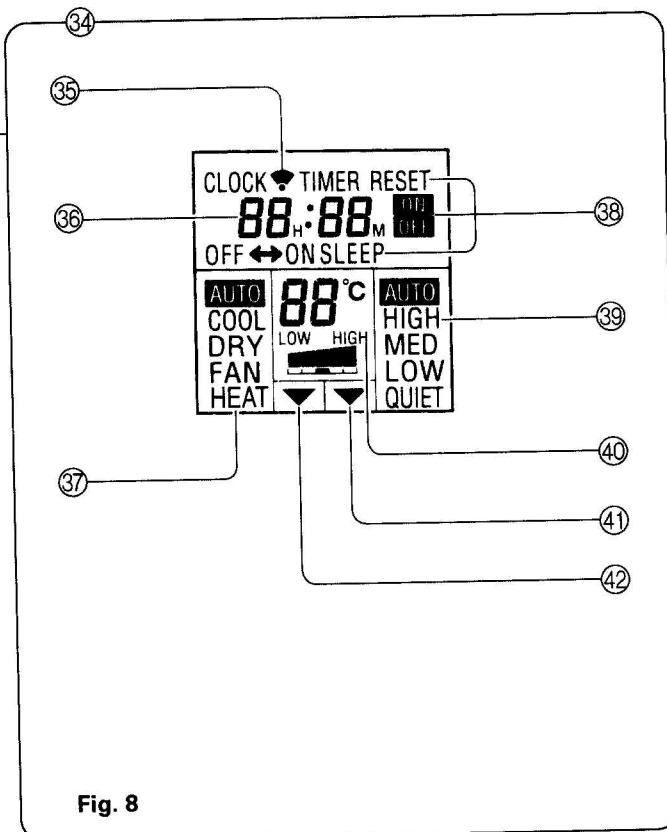

Fig. 8

EC DECLARATION OF CONFORMITY  
CE-KONFORMITÄTSEKRLÄRUNG  
DECLARATION DE CONFORMITE-CE  
CE DECLARACIÓN DE CONFORMIDAD  
DICHIARAZIONE DI CONFORMITÀ CE

ΔΗΛΩΣΗ ΕΓΚΡΙΣΗΣ ΚΑΤΑΛΛΗΛΟΤΗΤΑΣ  
CE VERKLARING VAN OVEREENSTEMMING  
EG-FÖRSÄKRAN OM ÖVERENSSTÄMMELSE  
DECLARAÇÃO DE CONFORMIDADE DA  
COMUNIDADE EUROPEIA (CE)

FUJITSU GENERAL (EURO) GmbH  
Werftstraße 20, D-40549 Düsseldorf, F. R. Germany

declares under its sole responsibility that the air conditioning models  
erklärt hiermit, daß die nachfolgend bezeichneten Raumklimageräte  
déclare sous sa seule responsabilité que les modèles de climatiseur ci-dessous  
declara bajo su exclusiva responsabilidad que los modelos de acondicionadores de aire  
dichiara sotto la sua unica responsabilità che i condizionatori d'aria modelli  
δηλώνει, ότι με δική της υπευθυνότητα τα μοντέλα των κλιματιστικών  
verklaart onder eigen verantwoordelijkheid dat de airconditioning-modellen  
intyggar på eget ansvar att luftkonditioneringsmodellerna  
declara sob sua responsabilidade que os modelos de ar condicionado

ASY9ASGCW/AOY9ANGC  
ASY12ASGCW/AOY12ASGC

ASY9RSGCW/AOY9RSGC  
ASY12RSGCW/AOY12RSGC

to which this declaration relates is in conformity with the following standards:  
worauf sich diese Konformitätserklärung bezieht, folgenden Richtlinien entspricht:  
auxquels la présente déclaration s'applique, sont conformes aux normes suivantes:  
como esta declaración especifica, cumplen con las siguientes normas:  
ai quali si riferisce la presente dichiarazione sono conformi ai seguenti standards:  
εις τα οποία η παρούσα δήλωση αναφέρεται, είναι προσαρμοσμένα σύμφωνα με τα παρακάτω πρότυπα:  
waarop deze verklaring van toepassing is, in conformiteit zijn met de volgende normen:  
till vilka denna deklaration är relaterade, är i överensstämmelse med följande standarder:  
indicados na declaração estão em conformidade com as normas seguintes:

a. EN 60 335-1  
b. EN 60 335-2-40  
c. EN 55 014

d. EN 50 082-1 (IEC801-2/IEC801-3/IEC801-4)  
e. EN 60 555-2

By conformance with the standards, the referenced products follows the provisions of the directives listed below:

In Übereinstimmung mit den Standards, erfüllen die obengenannten Produkte den Verordnungen der unten aufgeführten EG-Richtlinien:

Par leur conformité aux normes précitées, les appareils de ce type répondent aux exigences des directives suivantes:

De acuerdo con estas normas, los productos referenciados cumplen lo estipulado por las directivas listadas a continuación:

Od altri documenti normativi conformi alle disposizioni delle direttive sotto elencate:

Τα αναφερόμενα μοντέλα, σύμφωνα με τους κανονισμούς, ακολουθούν τις απαιτήσεις ασφαλείας των κάτωθι άρθρων:

Overeenkomstig de normen, voldoen de betreffende produkten aan de bepalingen van de hieronder vermelde richtlijnen:

Genom överensstämmelse med dessa standarder, uppfyller de berörda produkterna föreskrifterna i de direktiv som anges här nedan:

Os seguintes produtos referenciados na lista abaixo, estão em conformidade com as normas:

a. EC Council Directive 73/23/EEC

b. EC Council Directive 89/336/EEC

Place of Issue : F.R. Germany

Title of Authority : Administrator

Date of Issue : 4. February 1999

Declaration Reference : FUJITSU GENERAL  
(EURO) GmbH

Authorized by : Signature: 

Werftstraße 20, D-40549  
Düsseldorf, F. R. Germany

HISAKI HIROSAKI

FUJITSU GENERAL LIMITED  
1116, Suenaga, Takatsu-ku, Kawasaki 213-8502, Japan

# FEATURES AND FUNCTIONS

---

## **AUTOMATIC OPERATION**

Merely press the START/STOP button, and the unit will begin automatic operation in either the Heating, Cooling, Dry, or Monitor modes as appropriate, in accordance with the thermostat setting and the actual temperature of the room.

## **SLEEP TIMER**

When the SLEEP timer button is pressed during Heating mode, the air conditioner's thermostat setting is gradually lowered during the period of operation; during cooling mode, the thermostat setting is gradually raised during the period of operation. When the set time is reached, the unit automatically turns off.

## **WIRELESS REMOTE CONTROL UNIT**

The WIRELESS REMOTE CONTROL UNIT allows convenient control of air conditioner operation.

## **SWING OPERATION**

The Air Flow Direction Louvers swings automatically up and down so that the air speeds to every nook and corner of your room.

## **REMOVABLE INTAKE GRILLE**

The indoor unit's INTAKE GRILLE can be removed for easy cleaning and maintenance.

## **MILDEW-RESISTANT FILTER**

The AIR FILTER has been treated to resist mildew growth, thus allowing cleaner use and easier care.

## **SUPER QUIET OPERATION**

When the FAN CONTROL button is used to select QUIET, the unit begins super-quiet operation; the indoor unit's air-flow is reduced to produce quieter operation.

## **AIR CLEANING FILTER (Optional)**

The optional Air Cleaning Filter (Model APS-03B) uses an electrostatic principle to clean the air of fine particulate matter such as tobacco smoke and plant pollen.

## **POWER DIFFUSER (for warm air to your feet)**

When the Air Flow Direction Louvers are moved for downward blowing, the Power Diffuser opens in downward direction and generates a powerful air flow to warm your feet quickly and efficiently.

# NAME OF PARTS

**Fig. 1 Indoor Unit**

- ① Operating Control Panel (Fig. 2)
- ② POWER Switch
- ③ MANUAL AUTO button
- ④ Remote Control Signal Receiver
- ⑤ Indicator Lamps (Fig. 3)
  - ⑥ OPERATION Indicator Lamp (red)
  - ⑦ TIMER Indicator Lamp (green)
    - If the TIMER indicator lamp flashes when the timer is operating, it indicates that a fault has occurred with the timer setting (See Page 13 Auto Restart).
  - ⑧ SWING Indicator Lamp (orange)
- ⑨ Intake Grille (Fig. 4)
- ⑩ Air Filter
- ⑪ Air Flow Direction Louver
- ⑫ Right-Left Louver  
(behind Air Flow Direction Louver)
- ⑬ Power Diffuser
- ⑭ Drain Hose
- ⑮ Power Supply Plug
- ⑯ Power Supply Cord
- ⑰ Air Cleaning Filter (optional)

**Fig. 5 Outdoor Unit**

- ⑱ Intake Port
- ⑲ Outlet Port
- ⑳ Pipe Unit
- ㉑ Drain port (bottom)

**Fig. 6 Remote Control Unit**

- ㉒ SLEEP button
- ㉓ MASTER CONTROL button
- ㉔ SET TEMP./SET TIME buttons (+/-)
- ㉕ Signal Transmitter
- ㉖ TIMER button
- ㉗ FAN CONTROL button
- ㉘ START/STOP button
- ㉙ AIR FLOW DIRECTION button
- ㉚ SWING LOUVER button

**Rear side (Fig. 7)**

- ㉛ TIME ADJUST button
- ㉜ ACL button  
(located inside battery compartment)
- ㉝ TEST RUN button
  - This button is used when installing the conditioner, and should not be used under normal conditions, as it will cause the air conditioner's thermostat function to operate incorrectly.
  - If this button is pressed during normal operation, the unit will switch to test operation mode, and the Indoor Unit's OPERATION Indicator Lamp and TIMER Indicator Lamp will begin to flash simultaneously.
  - To stop the test operation mode, press the START/STOP button to stop the air conditioner.

**㉞ Remote Control Unit Display (Fig. 8)**

- ㉟ Transmit Indicator
- ㊱ Clock Display
- ㊲ Operating Mode Display
- ㊳ Timer Mode Display
- ㊴ Fan Speed Display
- ㊵ Temperature Set Display
- ㊶ Timer Set Indicator
- ㊷ Temperature Set Indicator

# PREPARATION

## Turn on the Power

- 1 Connect the Power Supply Plug (Fig. 1 ⑮) to an electrical outlet; in the case of a direct line connection, turn on the circuit breaker.**
- 2 Set the POWER switch (Fig. 2 ②) to ON.**

## Load Batteries (R03/LR03 × 2)

- 1 Press and slide the battery compartment lid on the reverse side to open it.**  
Slide in the direction of the arrow while pressing the ▼ mark.
- 2 Insert batteries.**  
Be sure to align the battery polarities (+/−) correctly.
- 3 Close the battery compartment lid.**

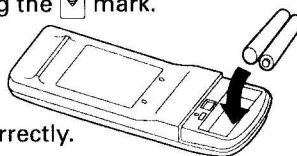

## ⚠ CAUTION!

- Take care to prevent infants from accidentally swallowing batteries.
- When not using the remote control unit for an extended period, remove the batteries to avoid possible leakage and damage to the unit.
- If leaking battery fluid comes in contact with your skin, eyes, or mouth, immediately wash with copious amounts of water, and consult your physician.
- Dead batteries should be removed immediately and disposed of properly, either in a battery collection receptacle or to the appropriate authority.
- Do not attempt to recharge dry batteries.

Never mix new and used batteries, or batteries of different types. Batteries should last about one year under normal use. If the remote control unit's operating range becomes appreciably reduced, replace the batteries and press the ACL button with the tip of a ballpoint pen or other small object.

## Set the Current time

- 1 Press the TIME ADJUST button (Fig. 7 ⑳).**  
Use the tip of a ball-point pen or other small object to press the button.
- 2 Use the (+/−)SET TIME buttons (Fig. 6 ㉔) to adjust the clock to the current time.**  
+ button: Press to advance the time.  
− button: Press to reverse the time.  
(Each time the buttons are pressed, the time will be advanced/reversed in one-minute increments; hold the buttons depressed to change the time quickly in ten-minute increments.)
- 3 Press the TIME ADJUST button again.**  
This completes the time setting and starts the clock.

## To Use the Remote Control Unit

- The Remote Control Unit must be pointed at signal receiver (Fig. 1 ④) to operate correctly.
- Operating Range: About 7 meters.
- When a signal is properly received by the air conditioner, a beeping sound will be heard.
- If no beep is heard, press the Remote Control Unit button again.

## Remote Control Unit Holder

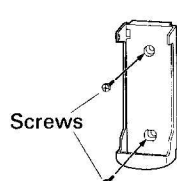

- ① Mount the Holder.

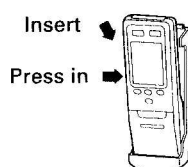

- ② Set the Remote Control Unit.

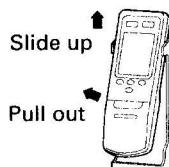

- ③ To remove the Remote Control Unit (when use at hand).

# OPERATION

## To Select Mode Operation

- 1 Press the **START/STOP** button (Fig.6 ㉘).  
The indoor unit's OPERATION indicator lamp (red) (Fig. 3 ㉖) will light.  
The air conditioner will start operating.
- 2 Press the **MASTER CONTROL** button (Fig.6 ㉚) to select the desired mode.  
Each time the button is pressed, the mode will change in the following order.

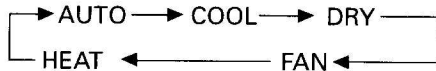

About three seconds later, the entire display will reappear.

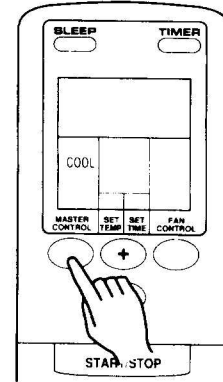

Example: When set to COOL.

## To Set the Thermostat

Press the **SET TEMP.** buttons (Fig. 6 ㉜).

- + button: Press to raise the thermostat setting.
- button: Press to lower the thermostat setting.

### ●Thermostat setting range:

AUTO .....	Standard temperature setting $\pm 2^{\circ}\text{C}$
Heating .....	16-30 $^{\circ}\text{C}$
Cooling/Dry .....	18-30 $^{\circ}\text{C}$

The thermostat cannot be used to set room temperature during the FAN mode (the temperature will not appear on the remote control unit's display).

About three seconds later, the entire display will reappear.

The thermostat setting should be considered a standard value, and may differ somewhat from the actual room temperature.

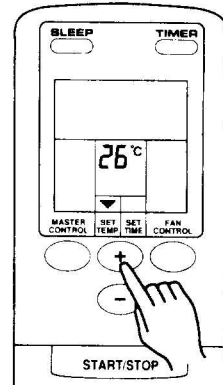

Example: When set to 26  $^{\circ}\text{C}$ .

## To Set the Fan Speed

Press the **FAN CONTROL** button (Fig. 6 ㉞).

Each time the button is pressed, the fan speed changes in the following order:



About three seconds later, the entire display will reappear.

### When set to AUTO:

- Heating** : Fan operates so as to optimally circulate warmed air.  
However, the fan will operate at very low speed when the temperature of the air issued from the indoor unit is low.
- Cooling** : As the room temperature approaches that of the thermostat setting, the fan speed becomes slower.
- Fan** : The fan alternately turns on and off; when on, the fan runs at the low fan speed.

The fan will operate at a very low setting during Monitor operation and at the start of the Heating mode.

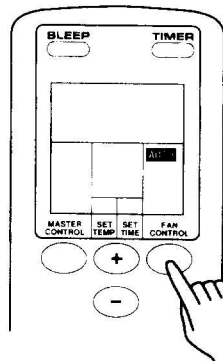

Example: When set to AUTO.

### When set to QUIET:

SUPER QUIET operation begins. The indoor unit's airflow will be reduced for quieter operation.

- SUPER QUIET operation cannot be used during Dry mode. (The same is true when dry mode is selected during AUTO mode operation.)
- During Super Quiet operation, Heating and Cooling performance will be reduced somewhat.



## To Stop Operation

### Press the START/STOP button.

The OPERATION Indicator Lamp (red) (Fig. 3 ⑥) will go out.

## About Mode Operation

- AUTO:**
- Depending on the room temperature at the time operation begins, the operating mode will be switched automatically as shown in the accompanying table.  
Also, depending on the operating mode, the room temperature setting will cause the "standard" temperature to be set as shown.

Actual Room Temperature		Operating Mode		Thermostat Setting (standard setting)
30 °C or above	→	Cooling	→	27 °C
27 °C-30 °C	→	Cooling	→	26 °C
24 °C-27 °C	→	Dry	→	24 °C
22 °C-24 °C	→	Monitor	→	
Below 22 °C	→	Heating	→	23 °C

The operating mode and standard thermostat settings are selected automatically when operation begins.

- When automatic operation is initiated, the fan will run at very low speed for about one minute while the unit detects and selects the proper operating mode.
- Once the operating mode has been set, the mode will not change even if the room temperature changes.  
However, during the monitor operation mode, if the room temperature changes to below 22°C, the mode will automatically switch to Heat, and when it rises above 24°C the mode will automatically switch to Dry.
- When in the monitor mode, the fan will operate very slowly.
- If the START/STOP button is pressed to recommence operation within two hours after stopping automatic operation, the unit will begin operating from the same mode as before.

- Heating:**
- Use to warm your room.
  - When Heating mode is selected, the air conditioner will operate at very low fan speed for about 3 to 5 minutes, after which it will switch to the selected fan setting. This period of time is provided to allow the indoor unit to warm up before begin full operation.
  - When the room temperature is very low, frost may form on the outside unit, and its performance may be reduced. In order to remove such frost, the unit will automatically enter the defrost cycle from time to time. During Automatic Defrosting operation, the OPERATION indicator lamp (red) will flash, and the heat operation will be interrupted.

- Cooling:**
- Use to cool your room.

- Dry:**
- Use for gently cooling while dehumidifying your room.
  - You cannot heat the room during Dry mode.
  - During Dry mode, the unit will operate at low speed; in order to adjust room humidity, the indoor unit's fan may stop from time to time. Also, the fan may operate at very low speed when detecting room humidity.
  - The fan speed cannot be changed manually when Dry mode has been selected.

- Fan:**
- Use to circulate the air throughout your room.

### During Heating mode:

Set the thermostat to a temperature setting that is higher than the current room temperature. The Heating mode will not operate if the thermostat is set lower than the actual room temperature.

### During Cooling/Dry mode:

Set the thermostat to a temperature setting that is lower than the current room temperature. The Cooling and Dry modes will not operate if the thermostat is set higher than the actual room temperature (in Cooling mode, the fan alone will operate).

### During Fan mode:

You can not use the unit to heat and cool your room.

# TIMER OPERATION

Before using the timer function, be sure that the Remote Control Unit is set to the correct current time (See page 4).

## To Use the ON timer or OFF timer

- 1 Press the START/STOP button (Fig. 6 ㉘)**  
**(if the unit is already operating, proceed to step 2).**  
The Indoor Unit's OPERATION Indicator Lamp (red) (Fig. 3 ㉞) will light.
- 2 Press the TIMER button (Fig. 6 ㉚) to select the OFF timer or ON timer operation.**  
Each time the button is pressed the timer function changes in the following order:

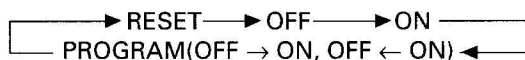

The Indoor Unit's TIMER Indicator Lamp (green) (Fig. 3 ㉟) will light.

- 3 Use the SET TIME buttons (Fig. 6 ㉜) to adjust the desired OFF time or ON time.**  
Set the time while the time display is flashing (the flashing will continue for about five seconds).

⊕ **button:** Press to advance the time.

⊖ **button:** Press to reverse the time.

About five seconds later, the entire display will reappear.

## To Use the PROGRAM timer

- 1 Press the START/STOP button (Fig. 6 ㉘)**  
**(if the unit is already operating, proceed to step 2).**  
The Indoor Unit's OPERATION Indicator Lamp (red) (Fig. 3 ㉞) will light.
- 2 Set the desired times for OFF timer and ON timer.**  
See the section "To Use the ON timer or OFF timer" to set the desired mode and times.  
About three seconds later, the entire display will reappear.  
The Indoor Unit's TIMER Indicator Lamp (green) (Fig. 3 ㉟) will light.
- 3 Press the TIMER button (Fig. 6 ㉚) to select the PROGRAM timer operation (either OFF → ON or OFF ← ON will display).**  
The display will alternately show "OFF timer" and "ON timer", then change to show the time setting for the operation to occur first.
  - The PROGRAM timer will begin operation. (If the ON timer has been selected to operate first, the unit will stop operating at this point.)

About five seconds later, the entire display will reappear.

## About the PROGRAM timer

- The PROGRAM timer allows you to integrate OFF timer and ON timer operations in a single sequence. The sequence can involve one transition from OFF timer to ON timer, or from ON timer to OFF timer, within a twenty-four hour period.
- The first timer function to operate will be the one set nearest to the current time. The order of operation is indicated by the arrow in the Remote Control Unit's display (OFF → ON, or OFF ← ON).
- One example of PROGRAM timer use might be to have the air conditioner automatically stop (OFF timer) after you go to sleep, then start (ON timer) automatically in the morning before you rise.

## To Cancel the Timer

Use the TIMER button to select "TIMER RESET".  
The air conditioner will return to normal operation.

## To Change the Timer Settings

Perform steps 2 and 3.

## To Stop Air Conditioner Operation while the Timer is Operating

Press the START/STOP button.

## To Change Operating Conditions

If you wish to change the operating conditions (Mode, Fan Speed, Thermostat Setting), after making the timer setting, wait until the entire display reappears, then press the appropriate buttons to change to the desired operating condition.

## To Cancel the Timer

Use the TIMER button to select "TIMER RESET".  
The air conditioner will return to normal operation.

## To Change the Timer Settings

1. Follow the instructions given in the section "To Use the ON Timer or OFF Timer" to select the timer setting you wish to change.
2. Press the TIMER button to select either OFF → ON or OFF ← ON.

## To Stop Air Conditioner Operation while the Timer is Operating

Press the START/STOP button.

## To Change Operating Conditions

If you wish to change operating conditions (Mode, Fan Speed, Thermostat Setting), after making the timer setting wait until the entire display reappears, then press the appropriate buttons to change the operating condition desired.

# SLEEP TIMER OPERATION

Unlike other timer functions, the SLEEP timer is used to set the length of time until air conditioner operate is stopped.

## To Use the SLEEP timer

**While the air conditioner is operating or stopped, press the SLEEP button (Fig. 6 ㉓).**

The Indoor Unit's OPERATION Indicator Lamp (red) (Fig. 3 ㉖) and the TIMER indicator lamp (green) (Fig. 3 ㉗) light.

## To Cancel the Timer:

Use the TIMER button to select "TIMER RESET".  
The air conditioner will return to normal operation.

## To Stop the Air Conditioner During Timer Operation:

Press the START/STOP button.

## To Change the Timer Settings

**Press the SLEEP button (Fig. 6 ㉓) once again and set the time using the SET TIME buttons (Fig. 6 ㉔).**

Set the time while the Timer Mode Display is flashing (the flashing will continue about five seconds).

- ⊕ button: Press to advance the time.
- ⊖ button: Press to reverse the time.

About five seconds later, the entire display will reappear.

## About the SLEEP timer

To prevent excessive warming or cooling during sleep, the SLEEP timer function automatically modifies the thermostat setting in accordance with the time setting. When the time has elapsed, the air conditioner completely stops.

### During Heating operation:

When the SLEEP timer is set, the thermostat setting is automatically lowered 1°C every thirty minutes. When the thermostat has been lowered a total of 4°C, the thermostat setting at that time is maintained until the set time has elapsed, at which time the air conditioner automatically turns off.

### During Cooling/Dry operation:

When the SLEEP timer is set, the thermostat setting is automatically raised 1°C every sixty minutes. When the thermostat has been raised a total of 2°C, the thermostat setting at that time is maintained until the set time has elapsed, at which time the air conditioner automatically turns off.

SLEEP timer setting

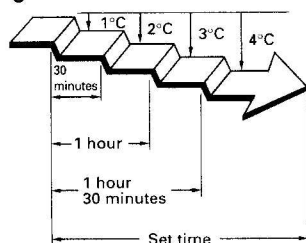

SLEEP timer setting

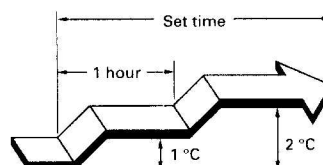

# ADJUSTING THE DIRECTION OF AIR CIRCULATION

Vertical (up-down) direction of airflow is adjusted by pressing the Remote Control Unit's AIR FLOW DIRECTION button. Horizontal (right-left) airflow direction is adjusted manually, by moving the Air Flow Direction Louvers. Whenever making horizontal airflow adjustments, start air conditioner operation and be sure that the vertical air direction louvers and the power diffuser (Fig. 1 ⑬) are stopped.

## Vertical Air Direction Adjustment

Press the AIR FLOW DIRECTION button (Fig. 6 ⑳).

Each time the button is pressed, the air direction range will change as follows:

① ↔ ② ↔ ③ ↔ ④ ↔ ⑤ ↔ ⑥ ↔ ⑦

### Types of Air flow Direction Setting:

- ①,②,③,④ : During Cooling/Dry modes
- ⑤,⑥,⑦ : During Heating mode

The remote Control Unit's display does not change.

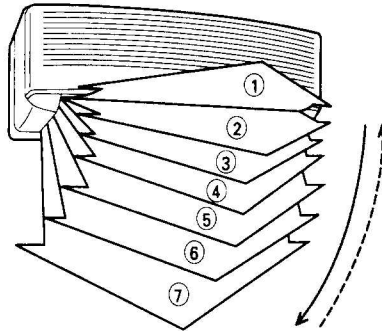

- Use the air direction adjustments within the ranges shown above.
- The vertical airflow direction is set automatically as shown, in accordance with the type of operation selected.
  - During Cooling/Dry mode : Horizontal flow ①
  - During Heating mode : Downward flow ⑦
- During AUTO mode operation, for the first minute after beginning operation, airflow will be horizontal ①; the air direction cannot be adjusted during this period.
- When the air flow is directed downwards (⑦) at the time of heating operation, the Power Diffuser opens automatically and generates a powerful air flow to warm your feet quickly and efficiently.

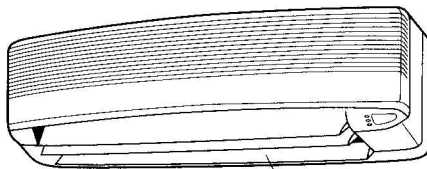

Power Diffuser  
(for warm air to your feet)

## ⚠ DANGER!

- Never place fingers or foreign objects inside the outlet ports, since the internal fan operates at high speed and could cause personal injury.

- Always use the remote control unit's AIR FLOW DIRECTION button to adjust the vertical airflow louvers. Attempting to move them manually could result in improper operation; in this case, stop operation and restart. The louvers should begin to operate properly again.
- During use of the Cooling and Dry modes, do not set the Air Flow Direction Louvers in the Heating range (⑤ - ⑦) for long periods of time, since water vapor may condense near the outlet louvers and drops of water may drip from the air conditioner. During the Cooling and Dry modes, if the Air Flow Direction Louvers are left in the heating range for more than 30 minutes, they will automatically return to position ④.
- When used in a room with infants, children, elderly or sick persons, the air direction and room temperature should be considered carefully when making settings.

- Always operate the Air Flow Direction Louvers and the Power Diffuser with the air flow direction buttons on the remote control. Forcible movement by hand can cause incorrect operation. In such a case, stop the operation to let the unit return to normal condition.
- Do not set the Air Flow Direction Louvers and the Power Diffuser for a long time to the heating mode (⑦) during cooling or drying operation. This can cause condensation at the discharge opening and dripping of water. (When operation is continued for 30 minutes or more in the heating mode ⑤ ⑥ ⑦, automatic return will be made to the direction ④.)

## Right-Left Adjustment

Adjust the Right-Left louvers.

- Move the Right-Left louvers to adjust air flow in the direction you prefer.

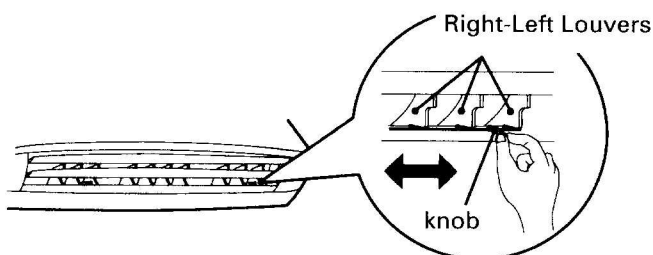

# SWING OPERATION

---

Begin air conditioner operation before performing this procedure.

## To select SWING Operation

**Press the SWING LOUVER button (Fig. 6 ㉔).**

The SWING indicator lamp (orange) (Fig. 3 ㉔) will light.

In this mode, the Air Flow Direction Louvers will swing automatically to direct the air flow both up and down.

## To Stop SWING Operation

**Press the SWING LOUVER button (Fig. 6 ㉔) once again.**

The SWING indicator lamp (orange) (Fig. 3 ㉔) will go out.

Airflow direction will return to the setting before swing was begun.

## About Swing Operation

- The range of swing is relative to the currently set airflow direction.
- If the swing range is not as desired, use the Remote Control Unit's AIR FLOW DIRECTION button to change the range of swing.
- During Cooling/Dry modes, if SWING Operation is continued at the lowest (downward) range for more than 30 minutes, the unit will automatically switch the swing range to the horizontal flow range, to prevent the condensation of moisture on the outlet.
- The SWING operation may stop temporarily when the air conditioner's fan is not operating, or when operating at very low speeds.

# MANUAL AUTO OPERATION

---

Use the MANUAL AUTO operation in the event the Remote Control Unit is lost or otherwise unavailable.

## How To Use the Main Unit Controls

**Press the MANUAL AUTO button (Fig. 2 ㉓) on the main unit control panel.**

To stop operation, press the MANUAL AUTO button once again, or set the POWER switch (Fig. 2 ㉔) to OFF.

(Controls are located inside the Intake Grille)

- When the air conditioner is operated with the controls on the Main Unit, it will operate under the same mode as the AUTO mode selected on the Remote Control Unit (see page 6).
- The fan speed selected will be "AUTO" and the thermostat setting will be standard.

# CLEANING AND CARE



## CAUTION!

- Before cleaning the air conditioner, be sure to turn it off and disconnect the Power Supply Cord.
- Be sure the Intake Grille (Fig. 1 ㉑) is installed securely.
- When removing and replacing the air filters, be sure not to touch the heat exchanger, as personal injury may result.

### Cleaning the Intake Grille

#### 1. Remove the Intake Grille.

- ① Place your fingers at both lower ends of the grille panel, and lift forward; if the Intake Grille seems to catch partway through its movement, continue lifting upward to remove.

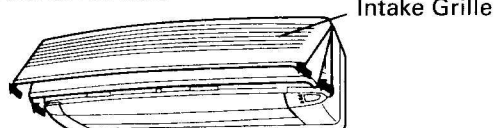

- ② Lift up the Intake Grille fully to remove.

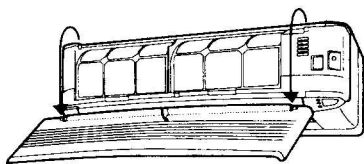

#### 2. Clean with water.

Remove dust with a vacuum cleaner; wipe the unit with warm water, then dry with a clean, soft cloth.

#### 3. Replace the Intake Grille.

- ① Holding the Intake Grille horizontally, fasten the two upper hooks on the unit.

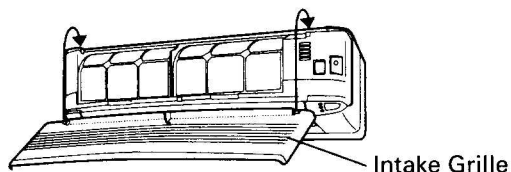

- ② Press the Intake Grille down at the lower sides to close.

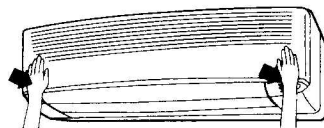

### Cleaning the Air Filter

#### 1. Open the Intake Grille, and remove the air filter.

Lift up the air filter's handle, disconnect the two lower tabs, and pull out.

Air filter handle

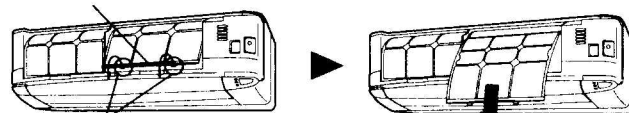

Hooks (two places)

#### 2. Remove dust with a vacuum cleaner or by washing.

After washing, allow to dry thoroughly in a shaded place.

#### 3. Replace the Air Filter and close the Intake Grille.

- ① Align the sides of the Air Filter with the panel, and push in fully, making sure the two lower tabs are returned properly to their holes in the panel.

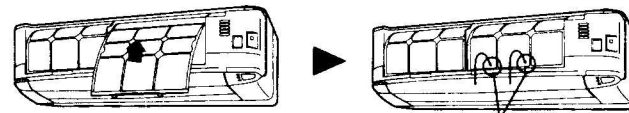

Hooks (two place)

- ② Close the Intake Grille.

(For purposes of example, the illustration shows the unit without Intake Grille installed.)

- Dust can be cleaned from the Air Filter either with a vacuum cleaner, or by washing the filter in a solution of mild detergent and warm water. If you wash the filter, be sure to allow it to dry thoroughly in a shady place before reinstalling.
- If dirt is allowed to accumulate on the Air Filter, air flow will be reduced, lowering operating efficiency and increasing noise.
- During periods of normal use, the Air Filters should be cleaned every two weeks.

### When using the optional Air Cleaning Filter

- Install the optional Air Cleaning Filter set (APS-03B) as instructed (installation instructions are furnished with the Air Cleaning Filter set).

- When used for extended periods, the unit may accumulate dirt inside, reducing its performance. We recommend that the unit be inspected regularly, in addition to your own cleaning and care. For more information, consult authorized service personnel.
- When cleaning the unit's body, do not use water hotter than 40 °C, harsh abrasive cleansers, or volatile agents like benzene or thinner.
- Do not expose the unit body to liquid insecticides or hairsprays.
- When shutting down the unit for one month or more, first allow the fan mode to operate continuously for about one-half day to allow internal parts to dry thoroughly.

# TROUBLESHOOTING



In the event of a malfunction (burning smell, etc.), immediately stop operation, disconnect the Power Supply Plug, and consult authorized service personnel.  
Merely turning off the unit's power switch will not completely disconnect the unit from the power source. Always be sure to disconnect the Power Supply Plug or turn off your circuit breaker to ensure that power is completely off.

Before requesting service, perform the following checks:

	Symptom	Problem	See Page
NORMAL FUNCTION	Doesn't operate immediately:	<ul style="list-style-type: none"> <li>● If the unit is stopped and then immediately started again, the compressor will not operate for about 3 minutes, in order to prevent fuse blowouts.</li> <li>● Whenever the Power Supply Plug is disconnected and then re-connected to a power outlet, the protection circuit will operate for about 3 minutes, preventing unit operation during that period.</li> </ul>	—
	Noise is heard:	<ul style="list-style-type: none"> <li>● During operation and immediately after stopping the unit, the sound of water flowing in the air conditioner's piping may be heard. Also, noise may be particularly noticeable for about 2 to 3 minutes after starting operation (sound of coolant flowing).</li> <li>● During operation, a slight squeaking sound may be heard. This is the result of minute expansion and contraction of the front cover due to temperature changes.</li> </ul>	—
		<ul style="list-style-type: none"> <li>● During Heating operation, a sizzling sound may be heard occasional. This sound is produced by the Automatic Defrosting operation.</li> </ul>	13
	Smells:	<ul style="list-style-type: none"> <li>● Some smell may be emitted from the indoor unit. This smell is the result of room smells (furniture, tobacco, etc.) which have been taken into the air conditioner.</li> </ul>	—
	Mist or steam are emitted:	<ul style="list-style-type: none"> <li>● During Cooling or Dry operation, a thin mist may be seen emitted from the indoor unit. This results from the sudden Cooling of room air by the air emitted from the air conditioner, resulting in condensation and misting.</li> </ul>	—
		<ul style="list-style-type: none"> <li>● During Heating operation, the outdoor unit's fan may stop, and steam may be seen rising from the unit. This is due to Automatic Defrosting operation.</li> </ul>	13
	Airflow is weak or stops:	<ul style="list-style-type: none"> <li>● When Heating operation is started, fan speed is temporarily very low, to allow internal parts to warm up.</li> <li>● During Heating operation, if the room temperature rises above the thermostat setting, the outdoor unit will stop, and the indoor unit will operate at very low fan speed. If you wish to warm the room further, set the thermostat for a higher setting.</li> </ul>	—
		<ul style="list-style-type: none"> <li>● During Heating operation, the unit will temporarily stop operation (between 7 and 15 minutes) as the Automatic Defrosting mode operates. During Automatic Defrosting operation, the OPERATION indicator lamp will flash.</li> </ul>	13
		<ul style="list-style-type: none"> <li>● The fan may operate at very low speed during Dry operation or when the unit is monitoring the room's temperature.</li> </ul>	5
		<ul style="list-style-type: none"> <li>● During SUPER QUIET operation, the fan will operate at very low speed.</li> </ul>	5
		<ul style="list-style-type: none"> <li>● In the monitor AUTO operation, the fan will operate at very low speed.</li> </ul>	5
		<ul style="list-style-type: none"> <li>● During Heating operation, water may be produced from the outdoor unit due to Automatic Defrosting operation.</li> </ul>	13
	Water is produced from the outdoor unit:	<ul style="list-style-type: none"> <li>● During Heating operation, water may be produced from the outdoor unit due to Automatic Defrosting operation.</li> </ul>	13

# TROUBLESHOOTING

	Symptom	Items to check	See Page
CHECK ONCE MORE	Doesn't operate at all:	<ul style="list-style-type: none"> <li>● Is the Power Supply Plug disconnected its outlet?</li> <li>● Has there been a power failure?</li> <li>● Has a fuse blown out, or a circuit breaker been tripped?</li> </ul>	—
		<ul style="list-style-type: none"> <li>● Is the main POWER Switch set to the OFF position?</li> </ul>	4
		<ul style="list-style-type: none"> <li>● Is the timer operating?</li> </ul>	7 - 8
	Poor Cooling performance:	<ul style="list-style-type: none"> <li>● Is the air filter dirty?</li> <li>● Air the air conditioner's intake grille or outlet port blocked?</li> <li>● Did you adjust the room temperature settings (thermostat) correctly?</li> <li>● Is there a window or door open?</li> <li>● In the case of Cooling operation, is a window allowing bright sunlight to enter? (Close the curtains.)</li> <li>● In the case of Cooling operation, are there heating apparatus and computers inside the room, or are there too many people in the room?</li> </ul>	—
		<ul style="list-style-type: none"> <li>● Is the unit set for SUPER QUIET operation?</li> </ul>	5
The unit operates differently from the Remote Control Unit's setting:	<ul style="list-style-type: none"> <li>● Are the Remote Control Unit's batteries dead?</li> <li>● Are the Remote Control Unit's batteries loaded properly?</li> </ul>	4	

If the problem persists after performing these checks, or if you notice burning smells, or the TIMER indicator Lamp (Fig. 3 ⑦) flashes, immediately stop operation, disconnect the Power Supply Plug (Fig. 1 ⑤), and consult authorized service personnel.

## OPERATING TIPS

### Operation and Performance

#### Heating Performance

- This air conditioner operates on the heat-pump principle, absorbing heat from outdoor air and transferring that heat indoors. As a result, the operating performance is reduced as outdoor air temperature drops. If you feel that insufficient heating performance is being produced, we recommend you use this air conditioner in conjunction with another kind of heating appliance.
- Heat-pump air conditioners heat your entire room by recirculating air throughout the room, with the result that some time may be required after first starting the air conditioner until the room is heated.

#### Microcomputer-controlled Automatic Defrosting

- When using the Heating mode under conditions of low outdoor temperature and high humidity, frost may form on the outdoor unit, resulting in reduced operating performance.  
In order to prevent this kind of reduced performance, this unit is equipped with a Microcomputer-controlled Automatic Defrosting function. If frost forms, the air conditioner will temporarily stop, and the defrosting circuit will operate briefly (for about 7-15 minutes).  
During Automatic Defrosting operation, the OPERATION indicator lamp (red) will flash.

### AUTO Restart

#### In Event of Power Interruption

- The air conditioner power has been interrupted by a power failure. The air conditioner will then restart automatically in its previous mode when the power is restored.
- Operated by setting before the power failure. Then, the Air Flow Direction Louvers will automatically change to their standard direction.
- If a power failure occurs during TIMER operation, the timer will be reset and the unit will begin (or stop) operation at the new time setting. In the event that this (kind of timer fault occurs the TIMER Indicator Lamp will flash (see Page. 3) ).
- Use of other electrical appliances (electric shaver, etc.) or nearby use of a wireless radio transmitter may cause the air conditioner to malfunction. In this event, temporarily disconnect the Power Supply Plug, reconnect it, and then use the Remote Control Unit to resume operation.



# OPERATING TIPS

---

## Temperature and Humidity Range

	<b>Cooling Mode</b>	<b>Dry Mode</b>	<b>Heating Mode</b>
<b>Outdoor temperature</b>	About 21-43 °C	About 21-43 °C	About -5-24 °C
<b>Indoor temperature</b>	About 18-32 °C	About 18-32 °C	About 27 °C or less

- If the air conditioner is used under higher temperature conditioner than those listed, the built-in protection circuit may operate to prevent internal circuit damage. Also, during Cooling and Dry modes, if the unit is used under conditions of lower temperature than those listed above, the heat-exchanger may freeze, leading to water leakage and other damage.
- Do not use this unit for any purposes other than the Cooling, Dehumidifying, and air-circulation of rooms in ordinary dwellings.
- If the unit is used for long periods under high-humidity conditions, condensation may form on the surface of the indoor unit, and drip onto the floor or other objects underneath. (About 80% or more)